



October 2017



# Product Index

## ● Pop-Ups

Impress Straight	12
Impress Options	14
Impress Options	16
Fabric	18
Fabric Premium	20
Magnetic	22
Magnetic Options	24
Tower	26

## ● Zipper-Walls

Curved	30
Straight	32
Arch	34
Wave	36
Moon	38
Banner	40
Sizes	42

## ● Roll-Banners

Selection table	48
Cube	50
Challenger	52
Triangle	54
Budget	56
Basic	58
Plus	60
Evolution	62
Massive	64
Twin	66
Premium	68
Deluxe	70
Double	72
Extreme	74
Mini	76

## ● Banner Stands

L-Banner Quick	80
L-Banner Telescopic	82
X-Banner Budget	84
X-Banner Premium	86
Panel Base Aluminium	88

## ● Lighting

Banner LED	92
Banner Light Halogen	94
Wall LED 50	96
Wall LED 116	98
Wall Light Halogen	100
Luxurious Light Bag	102
Wall Light Options	103

## ● Counters

Promotional	106
Professional Original M	108
Professional Original L	110
Professional Square	112
Professional Round	114
Fabric	116
Flex Counter	118

## ● Flex Tower

Flex Tower	122
------------	-----

## ● Brochure Holders

Magnetic	126
Budget	128
Easy	130
ZigZag	132
Deluxe	134

## ● Poster Holders

Poster Rail	138
Poster Frame	140
Poster Stand	142

## ● Outdoor

Streetboard	146
Outdoor Banner	148

## ● Flags

Beach Flag Alu Wind	152
Beach Flag Alu Drop	154
Beach Flag Alu Square	156
Beach Flag Fiber Wind/Drop	158
Beach Flag Base	160
Promo Flag Wind/Drop	164
Flagpole 415	166
Flagpole 540	168

## ● Cases

Hard Case	172
Trolley Case	173
Transport Trolley	174
Soft Trolley	175

# Visual Guide

These figures will be referenced on multiple product pages.

## 1. Packages



Fig. 1a  
ⓧ in Ⓨ



Fig. 1b  
ⓧ in Ⓩ

## 2. Pallets



Fig. 2a

Euro pallet: 80 x 120 cm  
Industrial pallet: 100 x 120 cm

# Pop-Ups

Impress Straight	12
Impress Options	14
Fabric	18
Fabric Premium	20
Magnetic	22
Magnetic Options	24
Tower	26

# Pop-up Impress Straight

NEW

'Dare to impress'

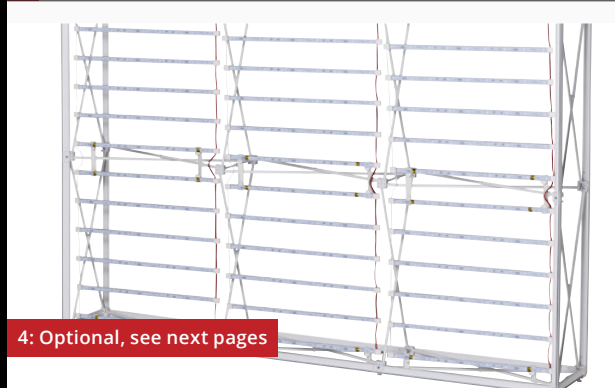
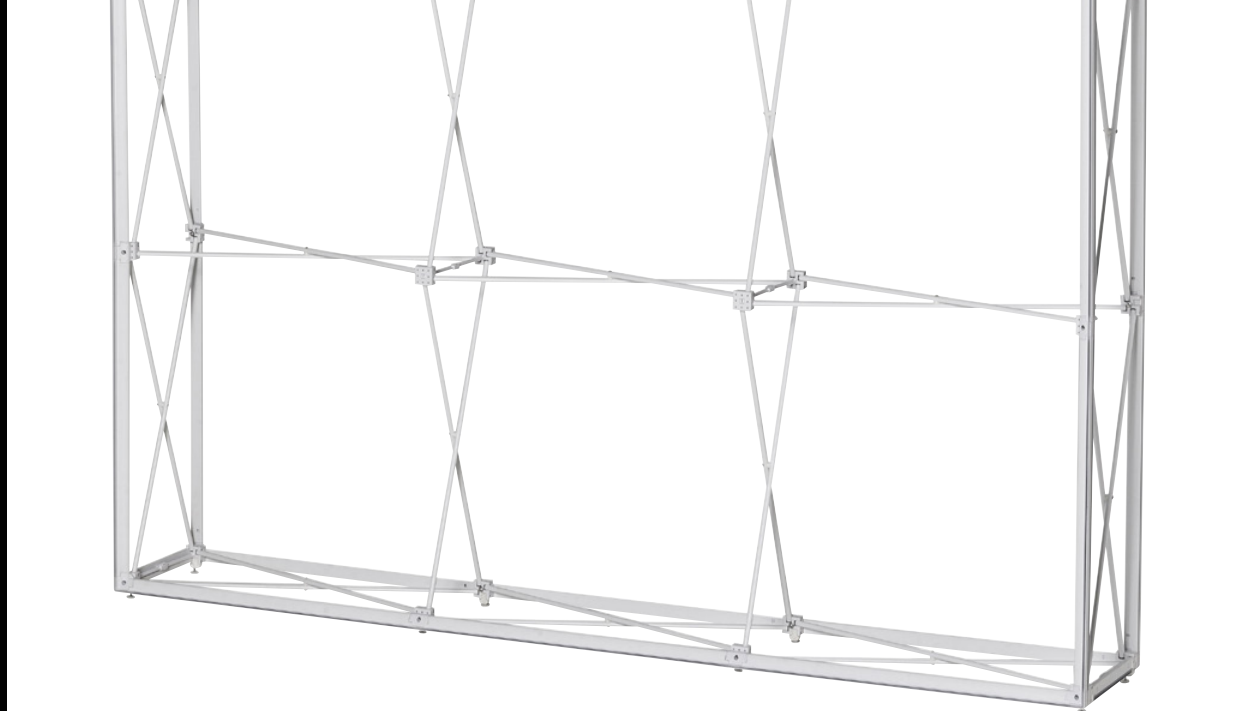

4: Optional, see next pages

5: Optional, see chapter Lighting on page 84



**!** Important: Available in 20 sizes

Width: Between 77 and 591 cm  
Height: Between 224 and 371 cm

Top view



### 3 levels high

Art. nr.	Frame	W	H	D
IMPR13S	1 x 3	77	224	36
IMPR23S	2 x 3	151	224	36
IMPR33S	3 x 3	224	224	36
IMPR43S	4 x 3	298	224	36
IMPR53S	5 x 3	371	224	36
IMPR63S	6 x 3	444	224	36
IMPR73S	7 x 3	517	224	36
IMPR83S	8 x 3	591	224	36

### Dimensions

### 4 levels high

Art. nr.	Frame	W	H	D
IMPR14S	1 x 4	77	298	36
IMPR24S	2 x 4	151	298	36
IMPR34S	3 x 4	224	298	36
IMPR44S	4 x 4	298	298	36
IMPR54S	5 x 4	371	298	36
IMPR64S	6 x 4	444	298	36
IMPR74S	7 x 4	517	298	36
IMPR84S	8 x 4	591	298	36

### Dimensions

### 5 levels high

Art. nr.	Frame	W	H	D
IMPR15S	1 x 5	77	371	36
IMPR25S	2 x 5	151	371	36
IMPR35S	3 x 5	224	371	36
IMPR45S	4 x 5	298	371	36

### Dimensions

All sizes in cm.

## Pop-Up Impress Straight

- EN**
- White aluminium frame with grooved bars that hold Silicone Edge Graphics (1)
  - Equipped with fixation for lighting (2)
  - Padded trolley with extra bag for storage bars (3)
  - **Optional:** LED light curtains and accessories (4)
  - **Optional:** LED or halogen lighting (5)

- DE**
- Weißer Aluminiumrahmen mit gerillten Schienen, die Silicone Edge Graphics halten (1)
  - Standardmäßig geliefert mit Befestigungssystem für die Beleuchtung (2)
  - Gepolsterter Trolley mit separater Hülle zum Aufbewahren der Stäbe (3)
  - **Optional:** LED-Lichtvorhänge und Zubehör (4)
  - **Optional:** LED- oder Halogenbeleuchtung (5)

- NL**
- Wit aluminium frame met gegroefde bars voor Silicone Edge Graphics (1)
  - Standaard voorzien van bevestigingssysteem voor verlichting (2)
  - Gevoerde trolley met losse hoes voor opbergen bars (3)
  - **Optioneel:** LED lichtgordijnen en bijbehorende accessoires (4)
  - **Optioneel:** LED of halogeenverlichting (5)

- FR**
- Cadre aluminium blanc avec barres rainurées pour Silicon Edge Graphics (1)
  - Fourni avec système de fixation pour éclairage (2)
  - Valise souple rembourée avec housse pour ranger les bars (3)
  - **Optionnel :** Rideaux lumière LED avec accessoires (4)
  - **Optionnel :** LED ou éclairage halogène (5)

- ES**
- Estructura de aluminio blanca con barras acanaladas para Silicon Edge Graphics (1)
  - Equipado con punto de fijación para iluminación (2)
  - Trolley acolchado con bolsa especial para guardar las barras (3)
  - **Opcional:** Cortinas de luz LED y accesorios (4)
  - **Opcional:** Iluminación LED o halógena (5)

**!** Attention: See next pages for options



Pop-up

NEW

# Impress Options



## Feet

- EN** Easy attachable feet in 3 colours (set of 2 pieces)
- DE** Einfach montierbare FüÙe in 3 Farben (2 Stück)
- NL** Eenvoudig te monteren voeten in 3 kleuren (set van 2)
- FR** Pieds en 3 couleurs simple à monter (kit de 2 pièces)
- ES** Pies fáciles de montar y en 3 colores (juego de 2 piezas)

Art. nr.	Product
IMPR-FTWH	Pop-Up Impress Feet White
IMPR-FTS	Pop-Up Impress Feet Silver
IMPR-FTB	Pop-Up Impress Feet Black

### 3 levels high



### 4 levels high

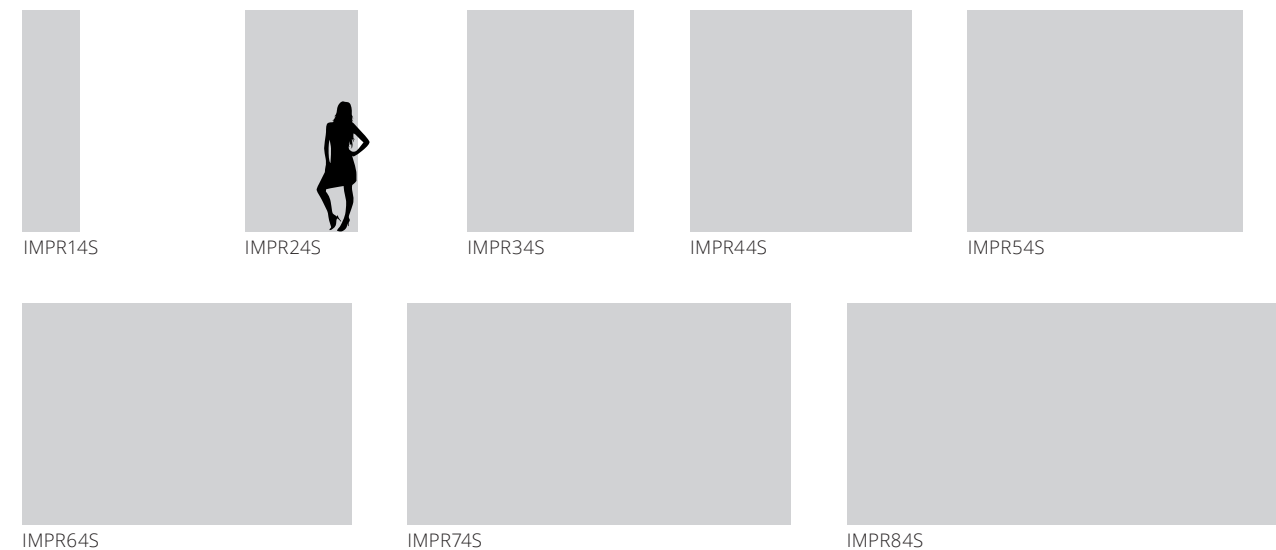

### 5 levels high

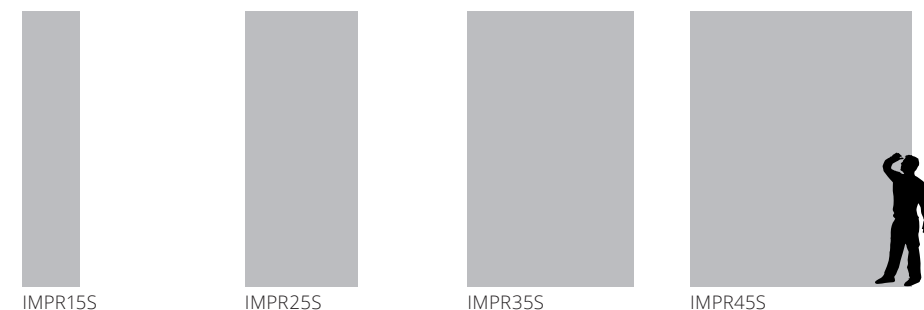

Sizes

# Pop-up Impress Options

NEW

## Extra Bars for Backside

- EN** Extra bars to attach graphic on backside frame (for top and bottom)
- DE** Extra Schienen um den Druck an der Rückseite zu befestigen (für Oberseite und Unterseite des Rahmens)
- NL** Extra bars om print aan achterkant te bevestigen (voor boven- en onderkant frame)
- FR** Barres additionnelles de fixation du visuel au verso de la structure ( pour le haut et le bas )
- ES** Barras adicionales para fijar el gráfico en la parte trasera de la estructura (parte superior e inferior)



### 3 levels high

Art. nr.	Product
IMPR13S-BARB	2 bars for backside
IMPR23S-BARB	4 bars for backside
IMPR33S-BARB	6 bars for backside
IMPR43S-BARB	8 bars for backside
IMPR53S-BARB	10 bars for backside
IMPR63S-BARB	12 bars for backside
IMPR73S-BARB	14 bars for backside
IMPR83S-BARB	16 bars for backside

### 4 levels high

Art. nr.	Product
IMPR14S-BARB	2 bars for backside
IMPR24S-BARB	4 bars for backside
IMPR34S-BARB	6 bars for backside
IMPR44S-BARB	8 bars for backside
IMPR54S-BARB	10 bars for backside
IMPR64S-BARB	12 bars for backside
IMPR74S-BARB	14 bars for backside
IMPR84S-BARB	16 bars for backside

### 5 levels high

Art. nr.	Product
IMPR15S-BARB	2 bars for backside
IMPR25S-BARB	4 bars for backside
IMPR35S-BARB	6 bars for backside
IMPR45S-BARB	8 bars for backside

## Blockout Film Backside

- EN**
- Seamless blockout film with reflective backing for backside frame
- DE**
- Nahtlose lichtblockierende Blockout-Folie mit reflektierendem Trägermaterial für Fensterrückseite
- NL**
- Naadloze block-out film met een reflecterende backing voor achterkant frame
- FR**
- Block-out film sans coutures avec support réfléchissant pour verso du cadre
- ES**
- Película de bloqueo sin costuras y con refuerzo reflectante para la parte posterior del cuadro



### 3 levels high

Art. nr.	Product
IMPR13S-BOB	Block-out Film 1 x 3
IMPR23S-BOB	Block-out Film 2 x 3
IMPR33S-BOB	Block-out Film 3 x 3
IMPR43S-BOB	Block-out Film 4 x 3
IMPR53S-BOB	Block-out Film 5 x 3
IMPR63S-BOB	Block-out Film 6 x 3
IMPR73S-BOB	Block-out Film 7 x 3
IMPR83S-BOB	Block-out Film 8 x 3

### 4 levels high

Art. nr.	Product
IMPR14S-BOB	Block-out Film 1 x 4
IMPR24S-BOB	Block-out Film 2 x 4
IMPR34S-BOB	Block-out Film 3 x 4
IMPR44S-BOB	Block-out Film 4 x 4
IMPR54S-BOB	Block-out Film 5 x 4
IMPR64S-BOB	Block-out Film 6 x 4
IMPR74S-BOB	Block-out Film 7 x 4
IMPR84S-BOB	Block-out Film 8 x 4

### 5 levels high

Art. nr.	Product
IMPR15S-BOB	Block-out Film 1 x 5
IMPR25S-BOB	Block-out Film 2 x 5
IMPR35S-BOB	Block-out Film 3 x 5
IMPR45S-BOB	Block-out Film 4 x 5

## LED Light Set for Backlit Display

- EN**
- Separate LED light curtains for backlit display
  - Including 200, 240 or 320 watt transformer
  - Including silicone edged block-out film for bottom, top and sides
- DE**
- Separate LED-Lichtvorhänge für hintergrundbeleuchtetes Display
  - Inklusive 200, 240 oder 320 Watt Transformator
  - Inklusive Blockout-Folie mit Silikonabschluss für Unterseite, Oberseite und Seitenflächen
- NL**
- Losse LED lichtgordijnen voor backlit display
  - Inclusief 200, 240 of 320 watt transformator
  - Inclusief silicone edged block-out film voor bodem, top en zijkanten
- FR**
- Rideaux lumière LED pour backlit display
  - Avec transformateur de 200, 240 ou 320 watt
  - Avec silicone edged block-out film pour fond, haut et côtés
- ES**
- Cortinas de luz LED opcionales para obtener un display iluminado
  - Incluye transformador de 200, 240 o 320 watt
  - Incluye Blockout film con bordes de silicona para las partes inferior, superior y laterales del display

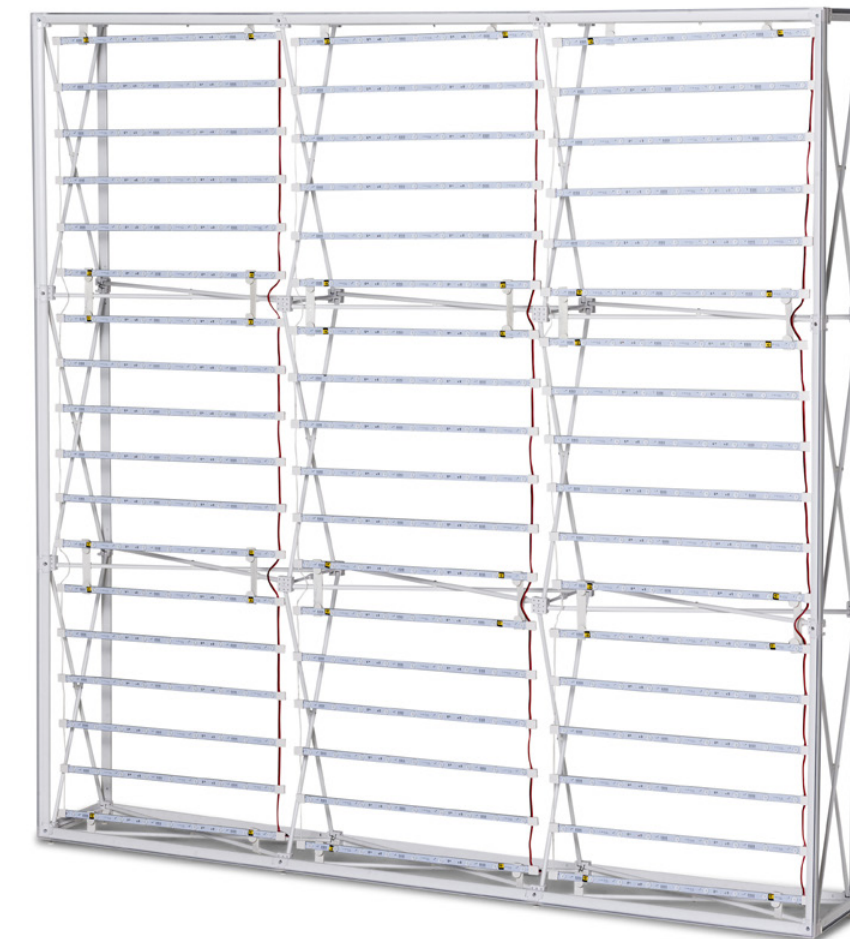

### 3 levels high

Art. nr.	Product
IMPR13S-LEDSET	LED Light Set 1 x 3
IMPR23S-LEDSET	LED Light Set 2 x 3
IMPR33S-LEDSET	LED Light Set 3 x 3
IMPR43S-LEDSET	LED Light Set 4 x 3
IMPR53S-LEDSET	LED Light Set 5 x 3
IMPR63S-LEDSET	LED Light Set 6 x 3
IMPR73S-LEDSET	LED Light Set 7 x 3
IMPR83S-LEDSET	LED Light Set 8 x 3

### 4 levels high

Art. nr.	Product
IMPR14S-LEDSET	LED Light Set 1 x 4
IMPR24S-LEDSET	LED Light Set 2 x 4
IMPR34S-LEDSET	LED Light Set 3 x 4
IMPR44S-LEDSET	LED Light Set 4 x 4
IMPR54S-LEDSET	LED Light Set 5 x 4
IMPR64S-LEDSET	LED Light Set 6 x 4
IMPR74S-LEDSET	LED Light Set 7 x 4
IMPR84S-LEDSET	LED Light Set 8 x 4

### 5 levels high

Art. nr.	Product
IMPR15S-LEDSET	LED Light Set 1 x 5
IMPR25S-LEDSET	LED Light Set 2 x 5
IMPR35S-LEDSET	LED Light Set 3 x 5
IMPR45S-LEDSET	LED Light Set 4 x 5



# Pop-up Fabric



1



2: Case type A, see Trolley Case on page 167

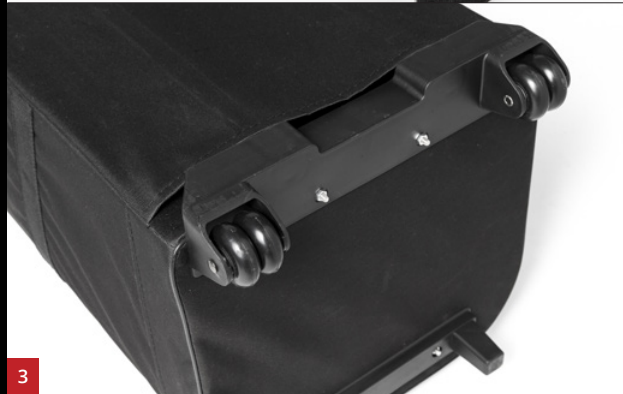

3



4: Case type B, soft bag



5: Optional, see chapter Lighting on page 84



6: Optional



## Optional velcro (6)

Product Velcro Loop (soft side)  
 Art. nr. VEL50L  
 Width 50mm  
 Length 25m

## Top view

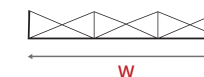

## Pop-Up Fabric

### EN

- 50 mm white hook velcro (hard side) (1)
- Stable mobile trolley M / L / XL (2)
- Wide wheel base with ball bearing wheels (3)
- Padded bag with braces and zipper over full length (4)
- **Optional:** LED or halogen lighting (5)
- **Optional:** Loop velcro (soft side) available (6)

### DE

- 50 mm weißes Klettband (1)
- Stabiler mobiler Trolley M / L / XL (2)
- Breiter Radstand mit kugelgelagerten Rädern (3)
- Verstärkte Tasche mit Innenfutter und Reißverschluss über die ganze Taschenlänge (4)
- **Optional:** LED- oder Halogenbeleuchtung (5)
- **Optional:** Flauschband erhältlich (6)

### NL

- 50 mm witte klittenband (haak) (1)
- Stabiele verrijdbare trolley M / L / XL (2)
- Brede wielbasis met kogelgelagerde wielen (3)
- Gevoerde tas met ritsluiting over volledige lengte (4)
- **Optioneel:** LED of halogeenverlichting (5)
- **Optioneel:** Lus klittenband (zachte kant) beschikbaar (6)

### FR

- Velcro male blanc 50 mm (côté dur) (1)
- Valise de transport stable M / L / XL (2)
- Position large des roues avec roulement à billes (3)
- Sac renforcé avec doublure et fermeture éclair sur toute la longueur (4)
- **Optionnel :** LED ou éclairage halogène (5)
- **Optionnel :** Velcro femelle (côté mou) disponible (6)

### ES

- Velcro de gancho blanco (cara dura) 50 mm (1)
- Trolley estable M / L / XL (2)
- Amplia distancia entre ruedas con cojinete de bolas (3)
- Bolsa acolchada y reforzada con cremallera a todo el largo (4)
- **Opcional:** Iluminación LED o halógena (5)
- **Opcional:** Velcro de bucle (cara suave) disponible (6)

CASE TYPE A: TROLLEY CASE	Art. nr.	Frame	Dimensions			Case Size	Package				Pallet capacity <i>See fig. 2a on page 3</i>	
			W	H	D		W	H	D	KG	Euro	Industrial
	PUF23S	2 x 3	151	224	30	M	39	97	39	12	12	12
	PUF33S	3 x 3	224	224	30	L	49	97	39	16	8	12
	PUF43S	4 x 3	297	224	30	L	49	97	39	17	8	12
	PUF53S	5 x 3	370	224	30	XL	59	97	39	20	8	8
CASE TYPE B: SOFT BAG	PUF23S-SB	2 x 3	151	224	30	-	29	85	28	8	18	27
	PUF33S-SB	3 x 3	224	224	30	-	29	85	28	10	18	27
	PUF43S-SB	4 x 3	297	224	30	-	40	85	28	12	18	20
	PUF53S-SB	5 x 3	370	224	30	-	40	85	28	14	18	20

*All sizes in cm.*

*Max. pcs. on pallet*



# Pop-up Fabric Premium



1: See Trolley Case on page 167



2: Optional



3: Optional, see chapter Lighting on page 84



4: Optional



Top view Straight (S)



Top view Curved (C)



W1

W1: WITHOUT SIDE PANELS



W2

W2: INCLUDING SIDE PANELS

#### Optional velcro (4)

Product	Velcro Loop (soft side)
Art. nr.	VEL50L
Width	50mm
Length	25m

#### Optional side panels

Product	Rounded side panels
Art. nr.	PUFPR

#### Pop-Up Fabric Premium

##### EN

- Backside fully equipped with velcro dots
- Stable mobile trolley M / L / XL (1)
- Wide wheel base with ball bearing wheels
- **Optional:** Rounded side panels, transporter bag included (2)
- **Optional:** LED or halogen lighting (3)
- **Optional:** Loop velcro (soft side) available (4)

##### DE

- Rückseite komplett ausgestattet mit Klettbandpunkten
- Stabiler mobiler Trolley M / L / XL (1)
- Breiter Radstand mit kugelgelagerten Rädern
- **Optional:** Gebogene Seitenteile inklusive Transporttasche (2)
- **Optional:** LED- oder Halogenbeleuchtung (3)
- **Optional:** Flauschband erhältlich (4)

##### NL

- Achterzijde volledig voorzien van klittenbandpunten
- Stabiele verrijdbare trolley M / L / XL (1)
- Brede wielbasis met kogelgelagerde wielen
- **Optioneel:** Gebogen zijpanelen inclusief transporttas (2)
- **Optioneel:** LED of halogeenverlichting (3)
- **Optioneel:** Lus klittenband (zachte kant) beschikbaar (4)

##### FR

- Verso complètement équipé de points velcro
- Stables valise de transport M / L / XL (1)
- Position large des roues avec roulement à billes
- **Optionnel :** Panneaux latéraux, sac de transport inclus (2)
- **Optionnel :** LED ou éclairage halogène (3)
- **Optionnel :** Velcro femelle (côte mou) disponible (4)

##### ES

- Parte de atrás completamente equipada de puntos de velcro
- Trolley estable M / L / XL (1)
- Amplia distancia entre ruedas con cojinete de bolas
- **Opcional:** Laterales curvados y bolsa de transporte (2)
- **Opcional:** Iluminación LED o halógena (3)
- **Opcional:** Velcro de bucle (cara suave) disponible (4)

#### Dimensions

Art. nr.	Frame	Dimensions				Trolley Size	Package				Pallet capacity		
		W1	W2	H	D		W	H	D	KG	Euro	Industrial	
STRAIGHT	PUFP23S	2 x 3	148	184	220	36	M	39	97	39	13	12	12
	PUFP33S	3 x 3	220	256	220	36	L	49	97	39	16	8	12
	PUFP43S	4 x 3	292	328	220	36	L	49	97	39	18	8	12
	PUFP53S	5 x 3	363	399	220	36	XL	59	97	39	21	8	8
CURVED	PUFP23C	2 x 3	150	190	220	44	M	39	97	39	13	12	12
	PUFP33C	3 x 3	218	258	220	52	L	49	97	39	16	8	12
	PUFP43C	4 x 3	284	324	220	66	L	49	97	39	18	8	12
	PUFP53C	5 x 3	347	387	220	82	XL	59	97	39	21	8	8

All sizes in cm.

#### Pallet capacity See fig. 2a on page 3

Euro	Industrial
8	12
8	12
8	8
12	12
8	12
8	12
8	8

Max. pcs. on pallet



# Pop-up Magnetic



2: Case type A, see Hard Case on page 166



3: Case type B, see Soft Trolley on page 169



4: Optional, see page 19



5: Optional, see chapter Lighting on page 84



Top view Curved



Top view Straight

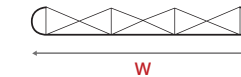

W

## Pop-Up Magnetic

### EN

- Reinforced 12 mm power magnets (1)
- Mobile hard case with firm divider to protect the prints (2)
- Padded trolley with tube bag to protect the print (3)
- **Optional:** Table top in 4 colours for hard case (4)
- **Optional:** LED or halogen lighting (5)

### DE

- Verstärkte 12 mm Magnete (1)
- Mobiler Transportkoffer mit Abtrennung zum Schutz der Drucke (2)
- Gepolsterter Trolley mit extra Tasche zum Schutz der Drucke (3)
- **Optional:** Thekenplatte in 4 Farben für Transportkoffer (4)
- **Optional:** LED- oder Halogenbeleuchtung (5)

### NL

- Versterkte 12 mm magneten (1)
- Verrijdbare hardcase met scheidingspaneel voor bescherming print (2)
- Gevoerde trolley met kokertas voor bescherming print (3)
- **Optioneel:** Balieblad in 4 kleuren voor hardcase (4)
- **Optioneel:** LED of halogeenverlichting (5)

### FR

- Aiments renforcés de 12 mm (1)
- Valise rigide avec séparateur fixe afin de protéger les visuels (2)
- Valise souple rembourée avec tube de protection pour les visuels (3)
- **Optionnel :** Tablette supérieure de 4 couleurs pour valise rigide (4)
- **Optionnel :** LED ou éclairage halogène (5)

### ES

- Imanes reforzados de 12 mm (1)
- Maleta rígida con separador firme para proteger los paneles (2)
- Trolley acolchada con estuche tubular para proteger la impresión (3)
- **Opcional:** Tablero del mostrador en 4 colores para la maleta rígida (4)
- **Opcional:** Iluminación LED o halógena (5)

**Attention:** See next page for options

## Dimensions

Size	W	H	D
2 x 3	192	224	51
3 x 3	252	224	69
4 x 3	301	224	100
5 x 3	341	224	129

## Package

HARD CASE				SOFT TROLLEY			
W	H	D	KG	W	H	D	KG
42	100	71	26	39	92	49	19
42	100	71	29	39	92	49	23
42	100	71	31	39	92	59	27
42	100	71	33	39	92	59	31

## Pallet capacity See fig. 2a on page 3

HARD CASE		SOFT TROLLEY	
Euro	Ind.	Euro	Ind.
4	6	8	12
4	6	8	12
4	6	8	10
4	6	8	10

Max. pcs. on pallet

	HARD CASE		SOFT TROLLEY	
	Art. nr.	Art. nr.	Size	W
CURVED	PUM23C	PUM23C-ST	2 x 3	192
	PUM33C	PUM33C-ST	3 x 3	252
	PUM43C	PUM43C-ST	4 x 3	301
	PUM53C	PUM53C-ST	5 x 3	341
STRAIGHT	PUM23S	PUM23S-ST	2 x 3	197
	PUM33S	PUM33S-ST	3 x 3	270
	PUM43S	PUM43S-ST	4 x 3	343
	PUM53S	PUM53S-ST	5 x 3	417

All sizes in cm.



Pop-up

# Magnetic Options



1



2

## Extra kit for new visuals

EN

- Plastic top strips (hangers) and plastic bottom strips (kickers) (1)
- Magnetic tape (3-poles) with strong TESA self-adhesive (2)

DE

- Kunststoffstreifen oben (Hängers) und Kunststoffstreifen unten (Kickers) (1)
- Magnetband (3-Polig) mit TESA-film (2)

NL

- Kunststof bovenstrips (hangers) en kunststof onderstrips (kickers) (1)
- Magneetband (3-Polig) met sterke TESA tape (2)

FR

- Bandes plastiques haut et bas (1)
- Bande magnétique (3 pôles) avec adhésif TESA (2)

ES

- Railes de plástico arriba (hangers) y abajo (kickers) (1)
- Cinta magnética (3 polos) con autoadhesivo TESA (2)

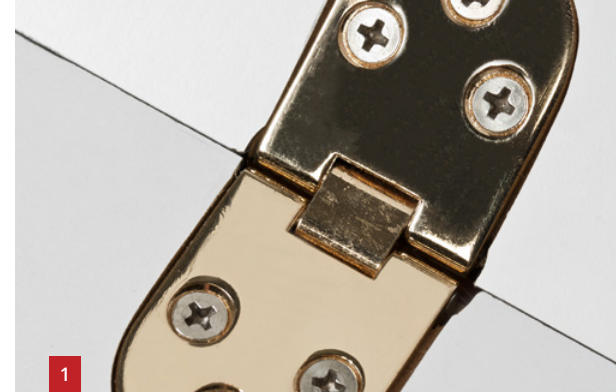

1



2

## Table Top

EN

- Table top in 4 colours
- Easily collapsible (1)
- Padded bag with zipper (2)

DE

- Thekenplatte in 4 Farben
- Einfach einklappbar (1)
- Tasche mit Innenfutter und Reißverschluss (2)

NL

- Balieblad in 4 kleuren
- Gemakkelijk inklapbaar (1)
- Tas met binnenvoering en ritsluiting (2)

FR

- Tablette supérieure de 4 couleurs
- Repli facilité (1)
- Sac rembourré avec fermeture éclair (2)

ES

- Tablero de mostrador en 4 colores
- Fácil de plegar (1)
- Bolsa acolchada con cremallera (2)



Art. nr.	Colour	Product
PUMTTB	●	Table Top Black
PUMTTW	●	Table Top Wood
PUMTTS	●	Table Top Silver
PUMTTWH	○	Table Top White

CURVED		STRAIGHT	
Art. nr.	Art. nr.	Art. nr.	Size
PUM23CKIT	PUM23SKIT	PUM23SKIT	2 x 3
PUM33CKIT	PUM33SKIT	PUM33SKIT	3 x 3
PUM43CKIT	PUM43SKIT	PUM43SKIT	4 x 3
PUM53CKIT	PUM53SKIT	PUM53SKIT	5 x 3

## Extension kit for backside

EN

- Magnetic bar with 5-poles magnetic tape (1)
- Magnets for backside frame (2)

DE

- Magnetschiene mit 5-poligem Magnetband (1)
- Magnet für Rückseite (2)

NL

- Magneetbar met 5-polige magneettape (1)
- Magneten voor achterzijde frame (2)

FR

- Barre magnétique avec bande magnétique 5 pôles (1)
- Aimants au verso du cadre (2)

ES

- Barra magnética con cinta magnética 5 polos (1)
- Imanes para uso en la parte de atrás de la estructura (2)

CURVED		STRAIGHT	
Art. nr.	Art. nr.	Art. nr.	Size
PUM23CE	PUM23SE	PUM23SE	2 x 3
PUM33CE	PUM33SE	PUM33SE	3 x 3
PUM43CE	PUM43SE	PUM43SE	4 x 3
PUM53CE	PUM53SE	PUM53SE	5 x 3



1



2

## Bag for new / backside visuals

- EN Extra tube bag to protect the print
- DE Extra Tasche zum Schutz der Drucke
- NL Extra kokertas voor bescherming print
- FR Sac supplémentaire pour protéger les visuals
- ES Estuche tubular adicional para proteger el visual

Art. nr.	Ø	H
PUM-BAGV5	27,5	80
<i>Bag for new visuals max 5 panels</i>		
PUM-BAGV7	30,5	80
<i>Bag for new visuals max 7 panels</i>		
PUM-BAGV5B	27,5	87
<i>Bag for backside visuals max 5 panels</i>		

All sizes in cm.





# Pop-up Tower

'Make an all-round impression'

20



## Pop-Up Tower

### EN

- Aluminium frame with patented hinges and magnetic locking (1)
- Padded trolley with tube bag to protect the print (2)
- Equipped with fixation for light (3)
- **Optional:** LED or halogen lighting (4)
- **Optional:** Extra kit for new visuals, including plastic top strips (hangers) and magnetic tape (3-poles) with strong TESA self-adhesive (5)

### DE

- Aluminiumrahmen mit patentierten Scharnieren und Magnetverriegelung (1)
- Gepolsteter Trolley mit extra Tasche zum Schutz der Drucke (2)
- Standardmäßig geliefert mit Befestigungssystem für die Beleuchtung (3)
- **Optional:** LED- oder Halogenbeleuchtung (4)
- **Optional:** Zusatzkit für neue Visuals, mit Kunststoffstreifen oben (Hänger) und Magnetband (3-Polig) mit starkem TESA-Film (5)

### NL

- Aluminium frame met gepatenteerde scharnieren en magneetsluiting (1)
- Gevoerde trolley met kokertas voor bescherming print (2)
- Standaard voorzien van bevestigingssysteem voor verlichting (3)
- **Optioneel:** LED of halogeenverlichting (4)
- **Optioneel:** Extra kit voor nieuwe visuals, met kunststof bovenstrips (hangers) en magneetband (3-polig) met sterke TESA tape (5)

### FR

- Structure aluminium avec charnière et fixation magnétique brevetées (1)
- Valise souple rembourée avec tube de protection pour les visuels (2)
- Fourni avec système de fixation pour lampe (3)
- **Optionnel :** LED ou éclairage halogène (4)
- **Optionnel :** Kit supplémentaire pour nouveaux visuels, avec bandes supérieures plastique (hangers) et bande magnétique (3 pôles) avec adhésif TESA (5)

### ES

- Estructura de aluminio con bisagras y cierre magnética patentadas (1)
- Trolley acolchada con estuche tubular para proteger la impresión (2)
- Equipado con punto de fijación para iluminación (3)
- **Opcional:** Iluminación LED o halógena (4)
- **Opcional:** Kit adicional para visuales nuevos, con raíles superiores de plástico (hangers) y cinta magnética (3 polos) con autoadhesivo TESA (5)

### Optional kit for new visuals (6)

Art. nr.	Product
PUTWRKIT	Extra kit for new visuals

Art. nr.	Dimensions		Package				Pallet capacity	
	Ø	H	W	H	D	KG	Euro	Industrial
PUTWR	64	225	30	91	43	16,5	12	16
All sizes in cm.								
							Max. pcs. on pallet	

4: Optional, see chapter Lighting on page 84

5: Optional

# Zipper-Walls

Curved	30
Straight	32
Arch	34
Wave	36
Moon	38
Banner	40
Sizes	42



# Zipper-Wall Curved



1



2



3



4: Optional, see chapter Lighting on page 84



5: Optional, see Wall Light Options on page 97



**! Important: Available in 9 sizes**

**Width:** Between 300 and 500 cm  
**Height:** Between 100 and 230 cm

**Example:** ZWC300-230:  
Width 300 cm and height 230 cm

Art. nr.	Dimensions			Trolley
	W	H	D	
ZWC300-100	300	100	60	M
ZWC400-100	400	100	80	L
ZWC500-100	500	100	100	L
ZWC300-150	300	150	60	L
ZWC400-150	400	150	80	L
ZWC500-150	500	150	100	L
ZWC300-230	300	230	60	L
ZWC400-230	400	230	80	XL
ZWC500-230	500	230	100	XL

All sizes in cm.

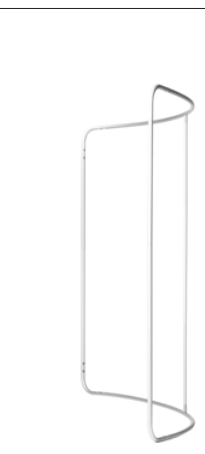

## Zipper-Wall **Curved**

### EN

- Anodised aluminium (Ø 34 mm) (1)
- Support pole (Ø 24 mm) with security clip (2)
- Reinforced transport trolley for durable professional use with ball bearing wheels (3)
- **Optional:** LED or halogen lighting (4)
- **Optional:** Clamp for lighting (5)

### DE

- Eloxiertes Aluminium (Ø 34 mm) (1)
- Stabilisierungsstange (Ø 24 mm) mit Sicherheitsclip (2)
- Verstärkter Transporttrolley für Langzeitgebrauch mit kugelgelagerten Rädern (3)
- **Optional:** LED- oder Halogenbeleuchtung (4)
- **Optional:** Klemme für Beleuchtung (5)

### NL

- Geanodiseerd aluminium (Ø 34 mm) (1)
- Ondersteuningspaal (Ø 24 mm) met borgveer (2)
- Verstevigde transporttrolley voor langdurig professioneel gebruik met kogelgelagerde wielen (3)
- **Optioneel:** LED of halogeenverlichting (4)
- **Optioneel:** Klem voor verlichting (5)

### FR

- Aluminium anodisé (Ø 34 mm) (1)
- Support de mât (Ø 24 mm) avec clip de sécurité (2)
- Valise de transport renforcée pour une utilisation professionnelle durable avec roulettes à roulement à billes (3)
- **Optionnel :** LED ou éclairage halogène (4)
- **Optionnel :** Fixation pour éclairage (5)

### ES

- Aluminio anodizado (Ø 34 mm) (1)
- Poste de soporte (Ø 24 mm) con clip de seguridad (2)
- Trolley de transporte reforzado para un uso duradero y profesional con ruedas con cojinetes (3)
- **Opcional:** Iluminación LED o halógena (4)
- **Opcional:** Abrazadera para iluminación (5)

# Zipper-Wall Straight



1



2



3



4: Optional, see chapter Lighting on page 84

5: Optional, see Wall Light Options on page 97

## Zipper-Wall **Straight**

### EN

- Anodised aluminium (Ø 34 mm) (1)
- Support pole (Ø 24 mm) with security clip (2)
- Reinforced transport trolley for durable professional use with ball bearing wheels (3)
- **Optional:** LED or halogen lighting (4)
- **Optional:** Clamp for lighting (5)

### DE

- Eloxiertes Aluminium (Ø 34 mm) (1)
- Stabilisierungsstange (Ø 24 mm) mit Sicherheitsclip (2)
- Verstärkter Transporttrolley für Langzeitgebrauch mit kugelgelagerten Rädern (3)
- **Optional:** LED- oder Halogenbeleuchtung (4)
- **Optional:** Klemme für Beleuchtung (5)

### NL

- Geanodiseerd aluminium (Ø 34 mm) (1)
- Ondersteuningspaal (Ø 24 mm) met borgveer (2)
- Verstevigde transporttrolley voor langdurig professioneel gebruik met kogelgelagerde wielen (3)
- **Optioneel:** LED of halogeenverlichting (4)
- **Optioneel:** Klem voor verlichting (5)

**!** Important: Available in 30 sizes

**Width:** Between 100 and 600 cm  
**Height:** Between 100 and 300 cm

**Example:** ZWS300-230:  
Width 300 cm and height 230 cm



### FR

- Aluminium anodisé (Ø 34 mm) (1)
- Support de mât (Ø 24 mm) avec clip de sécurité (2)
- Valise de transport renforcée pour une utilisation professionnelle durable avec roulette à roulement à billes (3)
- **Optionnel :** LED ou éclairage halogène (4)
- **Optionnel :** Fixation pour éclairage (5)

### ES

- Aluminio anodizado (Ø 34 mm) (1)
- Poste de soporte (Ø 24 mm) con clip de seguridad (2)
- Trolley de transporte reforzado para un uso durable y profesional con cojinete de bolas (3)
- **Opcional:** Iluminación LED o halógena (4)
- **Opcional:** Abrazadera para iluminación (5)

Art. nr.	Dimensions			Trolley Size	Art. nr.	Dimensions			Trolley Size
	W	H	D			W	H	D	
ZWS100-100	100	100	45	M	ZWS100-230	100	230	45	M
ZWS150-100	150	100	45	M	ZWS150-230	150	230	45	M
ZWS200-100	200	100	45	M	ZWS200-230	200	230	45	M
ZWS250-100	250	100	45	M	ZWS250-230	250	230	45	L
ZWS300-100	300	100	45	L	ZWS300-230	300	230	45	L
ZWS400-100	400	100	45	L	ZWS400-230	400	230	45	XL
ZWS500-100	500	100	45	XL	ZWS500-230	500	230	45	XL
ZWS600-100	600	100	45	XL	ZWS600-230	600	230	45	XL
ZWS100-150	100	150	45	M	ZWS100-250	100	250	45	M
ZWS150-150	150	150	45	M	ZWS150-250	150	250	45	M
ZWS200-150	200	150	45	M	ZWS200-250	200	250	45	M
ZWS250-150	250	150	45	M					
ZWS300-150	300	150	45	L	ZWS100-300	100	300	45	L
ZWS400-150	400	150	45	L	ZWS150-300	150	300	45	L
ZWS500-150	500	150	45	XL	ZWS200-300	200	300	45	L
ZWS600-150	600	150	45	XL					

All sizes in cm.



# Zipper-Wall Arch



1

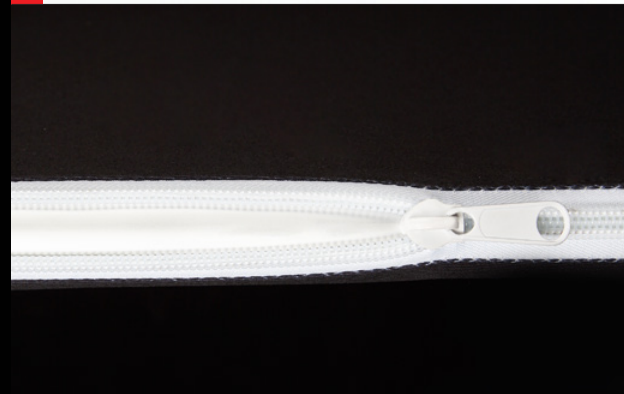

2



3



4: Optional, see chapter Lighting on page 84



5: Optional, see Wall Light Options on page 97

'Zip-up for a smooth presentation'



**! Important: Available in 8 sizes**

**Width:** Between 100 and 600 cm  
**Height:** 230 cm

**Example:** ZWA300-230:  
Width 300 cm and height 230 cm

Art. nr.

ZWA100-230  
ZWA150-230  
ZWA200-230  
ZWA250-230  
ZWA300-230  
ZWA400-230  
ZWA500-230  
ZWA600-230

All sizes in cm.

## Dimensions

W	H	D
100	230	50
150	230	50
200	230	50
250	230	50
300	230	50
400	230	50
500	230	50
600	230	50

## Trolley

Size

XL  
XL  
XL  
XL  
XL  
XL  
XL  
XL

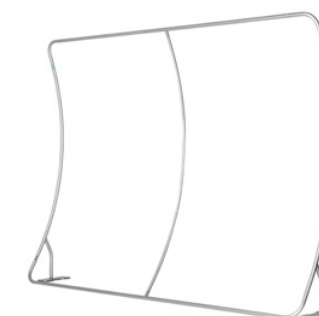

## Zipper-Wall Arch

EN

- Anodised aluminium (Ø 34 mm) (1)
- Solid powder coated steel base
- Support pole (Ø 24 mm) with security clip (2)
- Reinforced transport trolley for durable professional use with ball bearing wheels (3)
- **Optional:** LED or halogen lighting (4)
- **Optional:** Clamp for lighting (5)

DE

- Eloxiertes Aluminium (Ø 34 mm) (1)
- Solider pulverbeschichteter Stahlfuß
- Stabilisierungsstange (Ø 24 mm) mit Sicherheitsclip (2)
- Verstärkter Transporttrolley für Langzeitgebrauch mit kugelgelagerten Rädern (3)
- **Optional:** LED- oder Halogenbeleuchtung (4)
- **Optional:** Klemme für Beleuchtung (5)

NL

- Geanodiseerd aluminium (Ø 34 mm) (1)
- Stevige gepoedercoate stalen voet
- Ondersteuningspaal (Ø 24 mm) met borgveer (2)
- Verstevigde transporttrolley voor langdurig professioneel gebruik met kogelgelagerde wielen (3)
- **Optioneel:** LED of halogeenverlichting (4)
- **Optioneel:** Klem voor verlichting (5)

FR

- Aluminium anodisé (Ø 34 mm) (1)
- Base résistante avec revêtement poudre
- Support de mât (Ø 24 mm) avec clip de sécurité (2)
- Valise de transport renforcée pour une utilisation professionnelle durable avec roulette à roulement à billes (3)
- **Optionnel :** LED ou éclairage halogène (4)
- **Optionnel :** Fixation pour éclairage (5)

ES

- Aluminio anodizado (Ø 34 mm) (1)
- Base sólida lacado en mate
- Poste de soporte (Ø 24 mm) con clip de seguridad (2)
- Trolley de transporte reforzado para un uso durable y profesional con cojinete de bolas (3)
- **Opcional:** Iluminación LED o halógena (4)
- **Opcional:** Abrazadera para iluminación (5)

# Zipper-Wall Wave

NEW



1



2



3



4: Optional, see chapter Lighting on page 84



5: Optional, see Wall Light Options on page 97



## Zipper-Wall Wave

### EN

- Anodised aluminium (Ø 34 mm) (1)
- Support pole (Ø 24 mm) with security clip (2)
- Reinforced transport trolley for durable professional use with ball bearing wheels (3)
- **Optional:** LED or halogen lighting (4)
- **Optional:** Clamp for lighting (5)

### DE

- Eloxiertes Aluminium (Ø 34 mm) (1)
- Stabilisierungsstange (Ø 24 mm) mit Sicherheitsclip (2)
- Verstärkter Transporttrolley für Langzeitgebrauch mit kugelgelagerten Rädern (3)
- **Optional:** LED- oder Halogenbeleuchtung (4)
- **Optional:** Klemme für Beleuchtung (5)

### NL

- Geanodiseerd aluminium (Ø 34 mm) (1)
- Ondersteuningspaal (Ø 24 mm) met borgveer (2)
- Versterkte transporttrolley voor langdurig professioneel gebruik met kogelgelagerde wielen (3)
- **Optioneel:** LED of halogeenverlichting (4)
- **Optioneel:** Klem voor verlichting (5)

### FR

- Aluminium anodisé (Ø 34 mm) (1)
- Support de mât (Ø 24 mm) avec clip de sécurité (2)
- Valise de transport renforcée pour une utilisation professionnelle durable avec roulette à roulement à billes (3)
- **Optionnel :** LED ou éclairage halogène (4)
- **Optionnel :** Fixation pour éclairage (5)

### ES

- Aluminio anodizado (Ø 34 mm) (1)
- Poste de soporte (Ø 24 mm) con clip de seguridad (2)
- Trolley de transporte reforzado para un uso durable y profesional con cojinete de bolas (3)
- **Opcional:** Iluminación LED o halógena (4)
- **Opcional:** Abrazadera para iluminación (5)

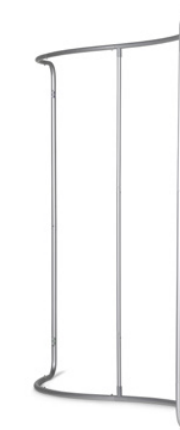

Art. nr.

ZW-Wave

All sizes in cm.

### Dimensions

W	H	D
300	230	45

### Trolley

Size

L



# Zipper-Wall Moon

NEW

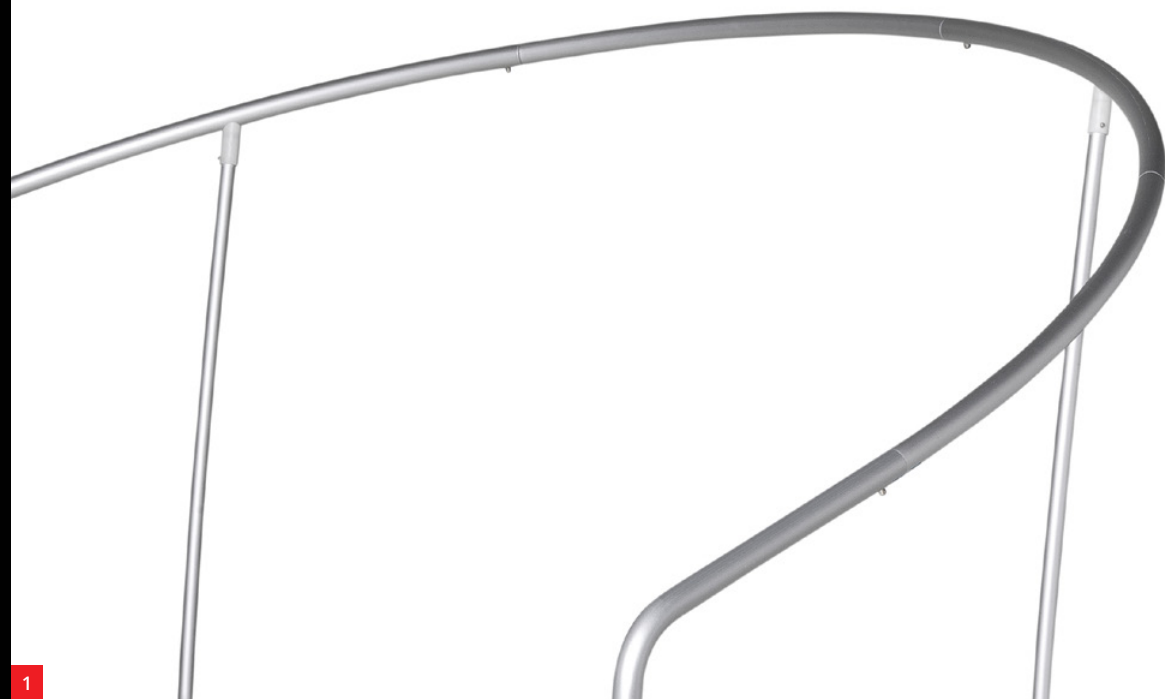

1

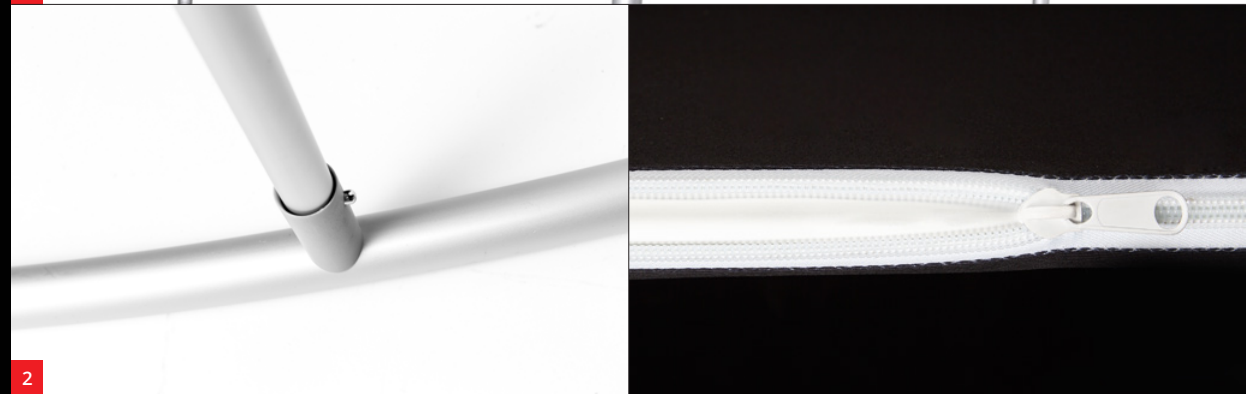

2



3



4: Optional, see chapter Lighting on page 84



5: Optional, see Wall Light Options on page 97



## Zipper-Wall Moon

### EN

- Anodised aluminium (Ø 34 mm) (1)
- Extremely stable due to smooth bended curve
- Support pole (Ø 24 mm) with security clip (2)
- Reinforced transport trolley for durable professional use with ball bearing wheels (3)
- **Optional:** LED or halogen lighting (4)
- **Optional:** Clamp for lighting (5)

### DE

- Eloxiertes Aluminium (Ø 34 mm) (1)
- Extrem stabil mit hoher Standfestigkeit aufgrund gekrümmter Form
- Stabilisierungsstange (Ø 24 mm) mit Sicherheitsclip (2)
- Verstärkter Transporttrolley für Langzeitgebrauch mit kugelgelagerten Rädern (3)
- **Optional:** LED- oder Halogenbeleuchtung (4)
- **Optional:** Klemme für Beleuchtung (5)

### Top view



### NL

- Geanodiseerd aluminium (Ø 34 mm) (1)
- Erg stabiel door vloeiend gebogen curve
- Ondersteuningspaal (Ø 24 mm) met borgveer (2)
- Verstevigde transporttrolley voor langdurig professioneel gebruik met kogelgelagerde wielen (3)
- **Optioneel:** LED of halogeenverlichting (4)
- **Optioneel:** Klem voor verlichting (5)

### FR

- Aluminium anodisé (Ø 34 mm) (1)
- Stabilité renforcée grâce à sa forme courbée
- Support de mât (Ø 24 mm) avec clip de sécurité (2)
- Valise de transport renforcée pour une utilisation professionnelle durable avec roulette à roulement à billes (3)
- **Optionnel :** LED ou éclairage halogène (4)
- **Optionnel :** Fixation pour éclairage (5)

### ES

- Aluminio anodizado (Ø 34 mm) (1)
- Extremadamente estable por su forma curvada
- Poste de soporte (Ø 24 mm) con clip de seguridad (2)
- Trolley de transporte reforzado para un uso durable y profesional con cojinete de bolas (3)
- **Opcional:** Iluminación LED o halógena (4)
- **Opcional:** Abrazadera para iluminación (5)



Art. nr.

ZW-Moon

All sizes in cm.

### Dimensions

W	H	D
280	200	170

### Trolley

Size

XL

# Zipper-Wall Banner

NEW



4: Optional, see chapter Lighting on page 84

5: Optional, see Wall Light Options on page 97



## Zipper-Wall Banner

### EN

- Anodised aluminium (Ø 34 mm) (1)
- Black steel plate, available in 3 width measurements (2)
- Padded bag with braces and zipper over full length (3)
- **Optional:** LED or halogen lighting (4)
- **Optional:** Clamp for lighting (5)

### DE

- Eloxiertes Aluminium (Ø 34 mm) (1)
- Schwarze Stahlplatte erhältlich in 3 Größen (2)
- Verstärkte Tasche mit Innenfutter und Reißverschluss über die ganze Taschenlänge (3)
- **Optional:** LED- oder Halogenbeleuchtung (4)
- **Optional:** Klemme für Beleuchtung (5)

### NL

- Geanodiseerd aluminium (Ø 34 mm) (1)
- Zwarte staalplaat in 3 breedtematen (2)
- Gevoerde tas met binnenvoering en ritssluiting over volledige lengte (3)
- **Optioneel:** LED of halogeenverlichting (4)
- **Optioneel:** Klem voor verlichting (5)

### FR

- Aluminium anodisé (Ø 34 mm) (1)
- Plaque en acier noir disponible en 3 largeurs (2)
- Sac renforcé avec doublure et fermeture éclair sur toute la longueur (3)
- **Optionnel :** LED ou éclairage halogène (4)
- **Optionnel :** Fixation pour éclairage (5)

### ES

- Aluminio anodizado (Ø 34 mm) (1)
- Placa de acero negro, disponible en 3 anchos distintos (2)
- Bolsa acolchada y reforzada con cremallera a todo lo largo (3)
- **Opcional:** Iluminación LED o halógena (4)
- **Opcional:** Abrazadera para iluminación (5)

**Important:** Available in 7 sizes

**Width:** Between 60 and 100 cm  
**Height:** Between 150 and 300 cm

**Example:** ZWB100-200:  
 Width 100 cm and height 200 cm

Art. nr.	Dimensions			Steel plate
	W	H	D	KG
ZWB060-150	60	150	25	5
ZWB060-200	60	200	25	5
ZWB080-150	80	150	25	7
ZWB080-200	80	200	25	7
ZWB100-200	100	200	25	9
ZWB100-250	100	250	25	9
ZWB100-300	100	300	25	9

All sizes in cm.

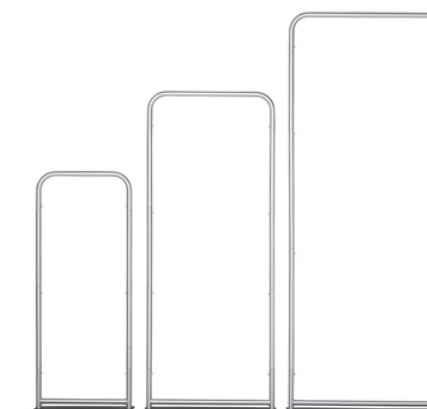



# Zipper-Wall Sizes

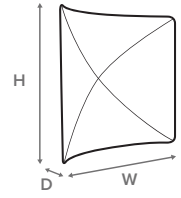

## Zipper-Wall **Curved**

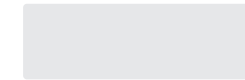

ZWC300-100

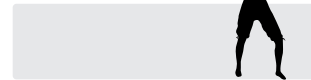

ZWC400-100

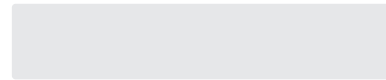

ZWC500-100



ZWC300-150



ZWC400-150



ZWC500-150



ZWC300-230



ZWC400-230



ZWC500-230

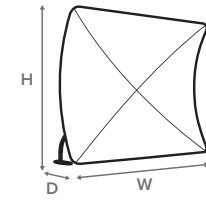

## Zipper-Wall **Arch**



ZWA100-230

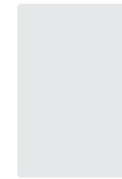

ZWA150-230

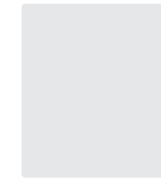

ZWA200-230

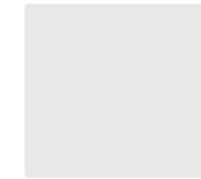

ZWA250-230

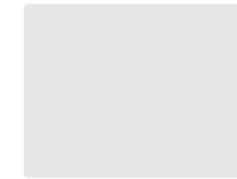

ZWA300-230

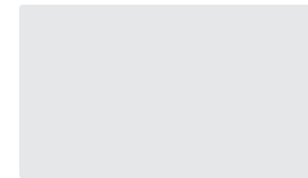

ZWA400-230

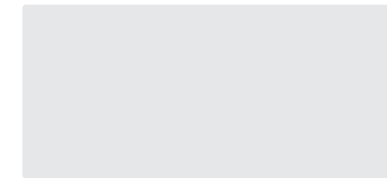

ZWA500-230

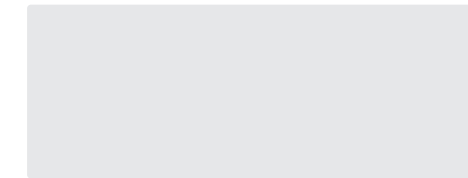

ZWA600-230

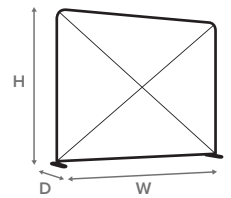

### Zipper-Wall **Straight**

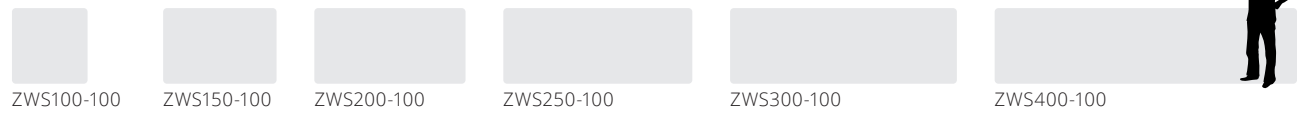

ZWS100-100   ZWS150-100   ZWS200-100   ZWS250-100   ZWS300-100   ZWS400-100



ZWS500-100   ZWS600-100

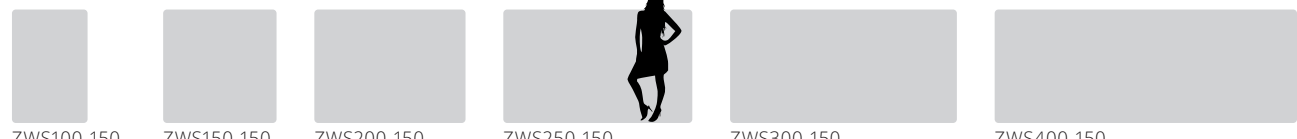

ZWS100-150   ZWS150-150   ZWS200-150   ZWS250-150   ZWS300-150   ZWS400-150



ZWS500-150   ZWS600-150



ZWS100-230   ZWS150-230   ZWS200-230   ZWS250-230   ZWS300-230   ZWS400-230



ZWS500-230   ZWS600-230



ZWS100-250   ZWS150-250   ZWS200-250   ZWS100-300   ZWS150-300   ZWS200-300

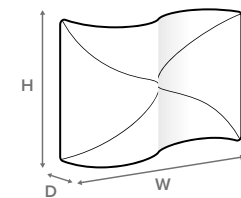

### Zipper-Wall **Wave**

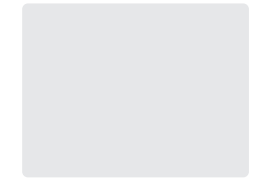

ZW-WAVE

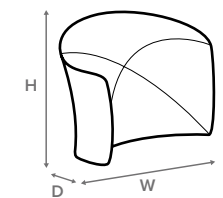

### Zipper-Wall **Moon**



ZW-MOON

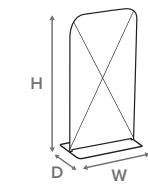

### Zipper-Wall **Banner**

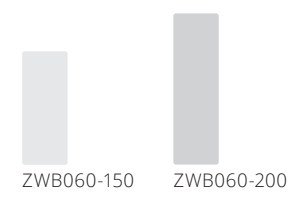

ZWB060-150   ZWB060-200

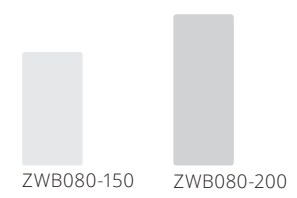

ZWB080-150   ZWB080-200

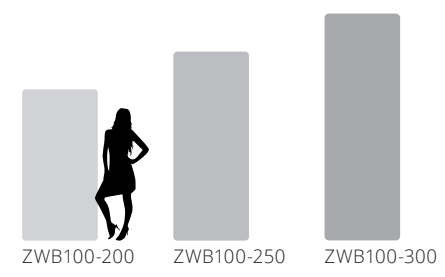

ZWB100-200   ZWB100-250   ZWB100-300



# Roll-Banners

	Selection table	48
<i>Favourite range</i>	Cube	50
	Challenger	52
	Triangle	54
<i>Classic range</i>	Budget	56
	Basic	58
	Plus	60
	Evolution	62
	Massive	64
	Twin	66
<i>High-end range</i>	Premium	68
	Deluxe	70
	Double	72
<i>Special range</i>	Extreme	74
	Mini	76

	Range	Page	Side view	Width	Height	Weight of product	Double sided printing	Number of poles	Telescopic pole	Height description on pole	Adhesive on bottom	Snap profile on bottom	Number of feet	Foot type (shape like)	Top profile type	Bag type	Foot type	Top profile type	Bag type
Cube	Favourite	50		60 80 85 100	200 200 200 200	1,6 1,9 2 2,2		1 1 1 1			x x x x		1 1 1 1	F1 F1 F1 F1	P1 P1 P1 P1	B1 B1 B1 B1			
Challenger Alu	Favourite	52		80 85 100	200 200 200	2 2,1 2,3		1 1 1			x x x		2 2 2	F2 F2 F2	P1 P1 P1	B3 B3 B3			
Challenger Next	Favourite	52		80 85 100	200 200 200	2 2,1 2,3		1 1 1			x x x		2 2 2	F3 F3 F3	P1 P1 P1	B3 B3 B3			
Challenger Black	Favourite	52		85 100	200 200	2,1 2,3		1 1			x x		2 2	F2 F2	P1 P1	B3 B3			
Triangle	Favourite	54		85 100 120 150	160-220 160-220 160-220 160-220	3,5 3,8 5,2 6,1		1 1 2 2	x x x x		x x x x		1 1 2 2	F4 F4 F4 F4	P2 P2 P2 P2	B4 B4 B4 B4			
Budget	Classic	56		80 85 100	200 200 200	1,8 1,9 2,1		1 1 1			x x x		2 2 2	F3 F3 F3	P1 P1 P1	B1 B1 B1			
Basic 1 foot	Classic	58		60 80 85 100	200 200 200 200	2,3 2,8 2,8 3,2		1 1 1 1			x x x x		1 1 1 1	F2 F2 F2 F2	P1 P1 P1 P1	B4 B4 B4 B4			
Basic 2 feet	Classic	58		80 85 100 120	200 200 200 200	2,8 2,8 3,2 3,9		1 1 1 2			x x x x		2 2 2 2	F2 F2 F2 F2	P1 P1 P1 P1	B4 B4 B4 B4			
Basic Black	Classic	58		85 100	200 200	2,8 3,2		1 1			x x		2 2	F2 F2	P1 P1	B4 B4			
Plus	Classic	60		40 60 80 85 100 120 150	200 200 200 200 200 200 200	1,6 2,2 2,2 2,8 3,2 4,1 4,8		1 1 1 1 1 2 2			x x x x x x x		1 2 2 2 2 2 2	F3 F3 F3 F3 F3 F3 F3	P2 P2 P2 P2 P2 P2 P2	B2 B2 B2 B2 B2 B2 B2			
Evolution	Classic	62		85 100 120 150	160-220 160-220 160-220 160-220	3,6 4,1 4,9 6		1 1 1 2	x x x x		x x x x		1 1 2 2	F5 F5 F5 F5	P3 P3 P3 P3	B4 B4 B4 B4			
Massive	Classic	64		85 100 120 150	160-220 160-220 160-220 160-220	4,1 5 6,3 7,6		1 1 1 2	x x x x		x x x x		1 1 2 2	F6 F6 F6 F6	P3 P3 P3 P3	B4 B4 B4 B4			
Twin	Classic	66		85 100	200 200	4,6 5,2	x x	1 1			x x		0 0		P1 P1	B5 B5			
Premium	High-end	68		85 100 120 150	160-220 160-220 160-220 160-220	5,7 6,8 8,3 10		1 1 1 2	x x x x		x x x x		0 0 0 0		P3 P3 P3 P3	B5 B5 B5 B5			
Premium Black	High-end	68		85 100	160-220 160-220	5,7 6,8		1 1	x x		x x		0 0		P3 P3	B5 B5			
DeLuxe	High-end	70		85 100 120	160-225 160-225 160-225	5,3 6 6,6		1 1 1	x x x	x x x		x x x	0 0 0		P3 P3 P3	B5 B5 B5			
Double	High-end	72		85 100 120	200 200 200	6,6 7,6 8,7	x x x	1 1 1			x x x		0 0 0		P3 P3 P3	B5 B5 B5			
Extreme	Special	74		150 200	170-270 170-300	9,8 11,6		2 2	x x	x x	x x		2 2	F4 F4	P4 P4	B4 B4			
Mini	Special	76		A4 A3	29,7 42	0,3 0,4		1 1			x x		0 0		P5 P5				

Selection table



Favourite range

NEW

# Roll-Banner Cube



## Roll-Banner **Cube**

- EN**
  - Slim and elegant top rail (1)
  - Reinforced pole holder (2)
  - Stable plastic foot
  - Bag with zipper (3)
- DE**
  - Elegantes Oberprofil (1)
  - Verstärkte Stangenhalterung (2)
  - Stabiler Plastikfuß
  - Tasche mit Reißverschluss (3)
- NL**
  - Elegant bovenprofiel (1)
  - Versterkte paalhouder (2)
  - Stabiele kunststof voet
  - Tas met ritssluiting (3)
- FR**
  - Rail au design fin et élégant (1)
  - Support-mât renforcé (2)
  - Pied en plastique stabilisée
  - Sac avec fermeture éclair (3)
- ES**
  - Perfil superior de diseño delgado y elegante (1)
  - Soporte para el mástil reforzado (2)
  - Pie de plástico estable
  - Bolsa con cremallera (3)

**! Important:**  
Single piece cardboard packaging not standard included

Art. nr.	Graphic		Specs			Package <i>See fig. 1a on page 3</i>					Pallet capacity <i>See fig. 2a on page 3</i>	
	W	H	Feet	Poles	KG	W	H	D	KG	⊗ in ⊙	Euro	Industrial
RBCUBE060	60	200	1	1	1,6	26	65	26	15,5	9	324	324
RBCUBE080	80	200	1	1	1,9	26	85	26	18	9	243	243
RBCUBE085	85	200	1	1	2	26	90	26	18,5	9	243	243
RBCUBE100	100	200	1	1	2,2	26	105	26	20,5	9	216	216

*All sizes in cm.*

*Max. pcs. on pallet*

Favourite range

# Roll-Banner Challenger

'Ready to challenge the market'

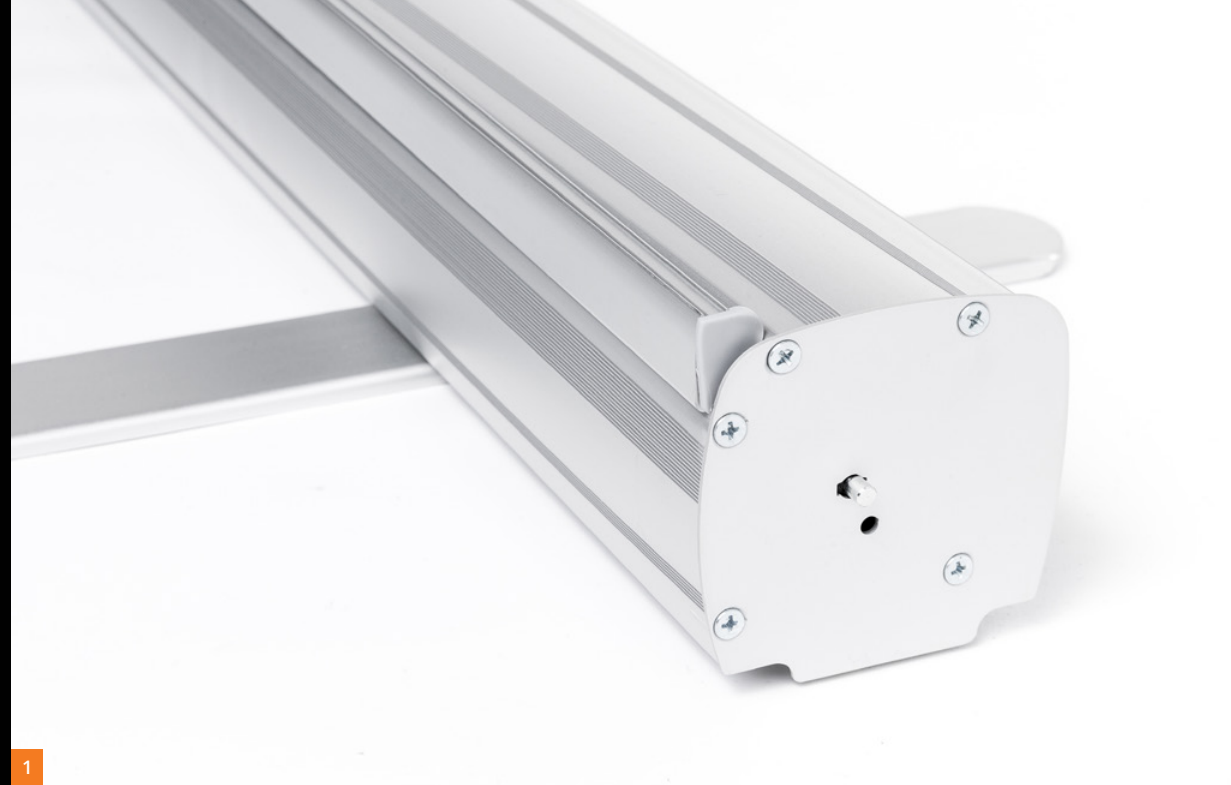

## Roll-Banner Challenger

### EN

- Side view of Challenger Alu (1)
- Side view of Challenger Next (2)
- Side view of Challenger Black (3)
- Reinforced pole holder (4)
- Slim and elegant top rail (5)
- Padded bag with zipper over full length (6)

### DE

- Seitenansicht des Challenger Alu (1)
- Seitenansicht des Challenger Next (2)
- Seitenansicht des Challenger Black (3)
- Verstärkte Stangenhalterung (4)
- Elegantes Oberprofil (5)
- Verstärkte Tasche mit Innenfutter und Reißverschluss über die ganze Taschenlänge (6)

### NL

- Zijaanzicht Challenger Alu (1)
- Zijaanzicht Challenger Next (2)
- Zijaanzicht Challenger Black (3)
- Versterkte paalhouder (4)
- Elegant bovenprofiel (5)
- Tas met verstevigingen en binnenvoering met ritsluiting over volledige lengte (6)

### FR

- Vue latérale du Challenger Alu (1)
- Vue latérale du Challenger Next (2)
- Vue latérale du Challenger Black (3)
- Support-mât renforcé (4)
- Rail au design fin et élégant (5)
- Sac renforcé avec doublure et fermeture éclair sur toute la longueur (6)

### ES

- Vista lateral del Challenger Alu (1)
- Vista lateral del Challenger Next (2)
- Vista lateral del Challenger Black (3)
- Soporte para el mástil reforzado (4)
- Perfil superior de diseño delgado y elegante (5)
- Bolsa acolchada y reforzada con cremallera a todo el largo (6)

Single piece cardboard packaging included

Art. nr.

Colour

RBCHA080  
RBCHA085  
RBCHA100

●  
●  
●

W H

80 200  
85 200  
100 200

Feet Poles KG

2 1 2  
2 1 2,1  
2 1 2,3

RBCHN080  
RBCHN085  
RBCHN100

●●  
●●  
●●

80 200  
85 200  
100 200

2 1 2  
2 1 2,1  
2 1 2,3

RBCHB085  
RBCHB100

●  
●

85 200  
100 200

2 1 2,1  
2 1 2,3

All sizes in cm.

## Graphic

## Specs

## Package See fig. 1a on page 3

## Pallet capacity See fig. 2a on page 3

W H D KG (X) in (Y)

33 88 22 14 6  
33 93 22 15 6  
33 108 22 17 6  
33 88 22 14 6  
33 93 22 15 6  
33 108 22 17 6  
33 93 22 15 6  
33 108 22 17 6

Euro Industrial

120 162  
120 162  
108 144  
120 162  
120 162  
108 144  
120 162  
108 144

Max. pcs. on pallet



Favourite range

# Roll-Banner Triangle

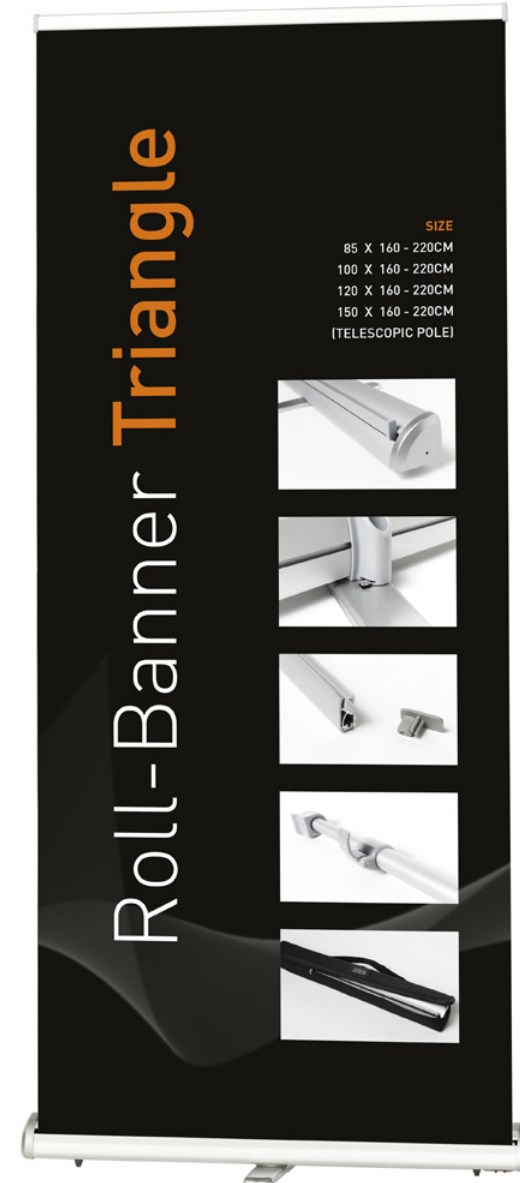
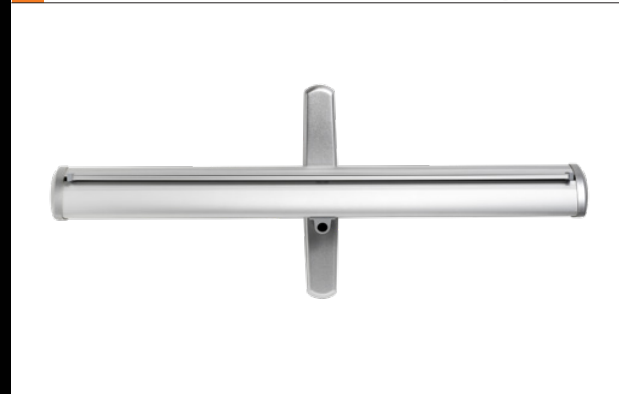

## Roll-Banner Triangle

### EN

- Modern top rail (1)
- Telescopic pole
- Powder coated steel foot with anti-slip pads (2)
- Padded bag with zipper over full length (3)
- Patented fixation for optimal banner angle (4)

### DE

- Modern Oberprofil (1)
- Teleskopstange
- Pulverbeschichtete Stahlfüße mit Anti-Rutschbelägen (2)
- Verstärkte Tasche mit Innenfutter und Reißverschluss über die ganze Taschenlänge (3)
- Patentierte Fixierung für optimale Stabilität (4)

### NL

- Modern bovenprofiel (1)
- Telescopische paal
- Gepoedercoate stalen voet met anti-slip pads (2)
- Tas met verstevigingen, binnenvoering en ritsluiting over volledige lengte (3)
- Gepatenteerde fixering voor optimale stabiliteit (4)

### FR

- Rail moderne (1)
- Mât télescopique
- Pied en acier revêtement peinture poudrée avec patins antidérapants (2)
- Sac renforcé avec doublure et fermeture éclair sur toute la longueur (3)
- Système de fixation breveté pour une stabilité optimale (4)

### ES

- Perfil superior de diseño moderno (1)
- Mástil telescópico
- Pie de acero lacado en mate con fondo anti-resbalo (2)
- Bolsa acolchada y reforzada con cremallera a todo el largo (3)
- Sistema de enganche patentado para una estabilidad optima (4)

✓ Single piece cardboard packaging included

Art. nr.	Graphic		Specs			Package <i>See fig. 1a on page 3</i>					Pallet capacity <i>See fig. 2a on page 3</i>	
	W	H	Feet	Poles	KG	W	H	D	KG	⊗ in ⊕	Euro	Industrial
RBTR085	85	160 - 220	1	1	3,5	39	99	30	22	6	96	108
RBTR100	100	160 - 220	1	1	3,8	39	113	30	25	6	84	90
RBTR120	120	160 - 220	2	2	5,2	29	133	27	13	4	48	48
RBTR150	150	160 - 220	2	2	6,1	26	163	16	13	2	48	48

*All sizes in cm.*

*Max. pcs. on pallet*

Classic range

# Roll-Banner Budget

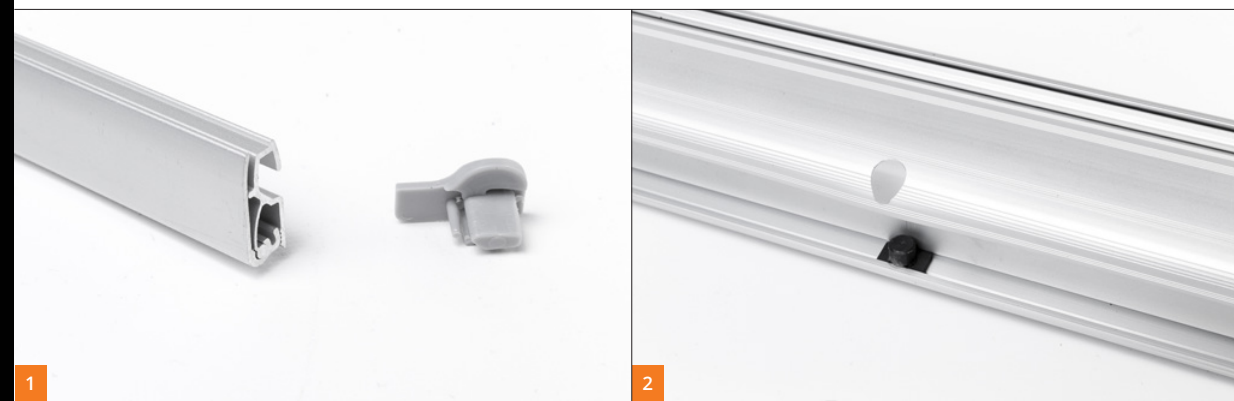

## Roll-Banner Budget

### EN

- Slim and elegant top rail (1)
- Rubber button as pole locator (2)
- Aluminium feet with black caps (2)
- Bag with zipper (3)

### DE

- Elegantes Oberprofil (1)
- Gummiknopf als Stangenlocator (2)
- Aluminiumfüße mit schwarzen Kappen (2)
- Tasche mit Reißverschluss (3)

### NL

- Elegant bovenprofiel (1)
- Rubberen knop als paal locator (2)
- Aluminium voeten met zwarte kapjes (2)
- Tas met ritssluiting (3)

### FR

- Rail au design fin et élégant (1)
- Socle en caoutchouc de maintien du mât (2)
- Pieds en aluminium avec embouts noirs (2)
- Sac avec fermeture éclair (3)

### ES

- Perfil superior de diseño delgado y elegante (1)
- Botón de goma para localizar el poste (2)
- Pie de aluminio con caperuzas negras (2)
- Bolsa con cremallera (3)

✓ Single piece cardboard packaging included

50

Art. nr.	Graphic		Specs			Package <i>See fig. 1a on page 3</i>					Pallet capacity <i>See fig. 2a on page 3</i>	
	W	H	Feet	Poles	KG	W	H	D	KG	⊗ in ⊙	Euro	Industrial
RBB080	80	200	2	1	1,8	40	85	20	16,5	8	208	264
RBB085	85	200	2	1	1,9	40	90	20	17,5	8	208	264
RBB100	100	200	2	1	2,1	40	105	20	19	8	192	240

*All sizes in cm.*

*Max. pcs. on pallet*



Classic range

# Roll-Banner Basic

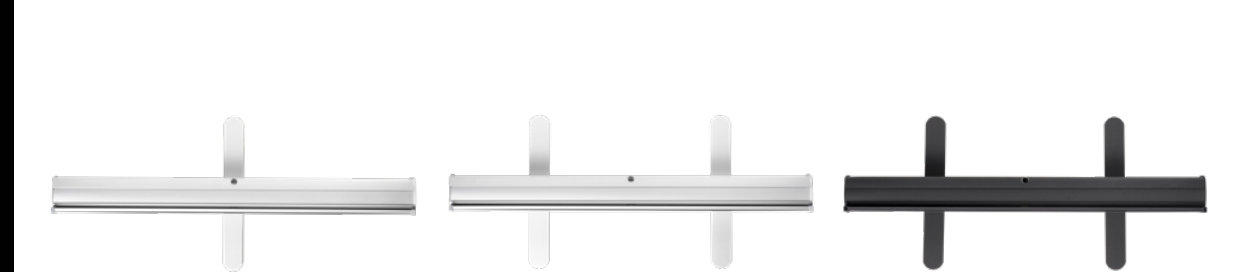

## Roll-Banner Basic

- EN**
- Slim and elegant top rail (1)
  - Plastic pole locator (2)
  - Full aluminium feet 1 or 2 pieces
  - Padded bag with zipper over full length (3)
  - **Optional:** Extension pole (+20 cm height) (4)
- DE**
- Elegantes Oberprofil (1)
  - Kunststoff-Stangenlocator (2)
  - FüÙe, 1 oder 2 Stück, komplett aus massivem Aluminium
  - Verstärkte Tasche mit Innenfutter und Reißverschluss über die ganze Taschenlänge (3)
  - **Optional:** Verlängerungsstange (+20 cm Höhe) (4)
- NL**
- Elegant bovenprofiel (1)
  - Kunststof paal locator (2)
  - Volledig aluminium voeten 1 of 2 stuks
  - Tas met verstevigingen en binnenvoering met ritsluiting over volledige lengte (3)
  - **Optioneel:** Verlengstuk paal (+20 cm hoogte) (4)
- FR**
- Rail au design fin et élégant (1)
  - Socle en plastique de maintien du mât (2)
  - Pieds en aluminium simple ou double
  - Sac renforcé avec doublure et fermeture éclair sur toute la longueur (3)
  - **Optionnel :** Barre d'extension (+20 cm de hauteur) (4)
- ES**
- Perfil superior de diseño delgado y elegante (1)
  - Indicador de plástico de posición del poste (2)
  - Pies de aluminio, 1 ó 2 unidades
  - Bolsa acolchada y reforzada con cremallera a todo el largo (3)
  - **Opcional:** Poste de extensión (+20 cm de altura) (4)

### Optional extension pole (4)

Art. nr.	Product
P20RBBAS	Lengthening pole (+20 cm height)
P20RBBASB	Lengthening pole (+20 cm height, black)

Single piece cardboard packaging included

Art. nr.	Colour	Graphic		Specs			Package <i>See fig. 1a on page 3</i>					Pallet capacity <i>See fig. 2a on page 3</i>	
		W	H	Feet	Poles	KG	W	H	D	KG	⊗ in ⊙	Euro	Industrial
RBBAS1F060	●	60	200	1	1	2,3	37	69	26	15	6	162	198
RBBAS1F080	●	80	200	1	1	2,8	37	88	26	17	6	120	138
RBBAS1F085	●	85	200	1	1	2,8	37	93	26	17	6	120	138
RBBAS1F100	●	100	200	1	1	3,2	37	108	26	20	6	108	120
RBBAS2F080	●	80	200	2	1	2,8	37	88	26	17	6	120	138
RBBAS2F085	●	85	200	2	1	2,8	37	93	26	17	6	120	138
RBBAS2F100	●	100	200	2	1	3,2	37	108	26	20	6	108	120
RBBAS2F120	●	120	200	2	2	3,9	26	130	26	17	4	48	48
RBBASB085	●	85	200	2	1	2,8	37	93	26	18	6	120	138
RBBASB100	●	100	200	2	1	3,2	37	108	26	20	6	108	120

All sizes in cm.

Max. pcs. on pallet

Classic range

# Roll-Banner Plus

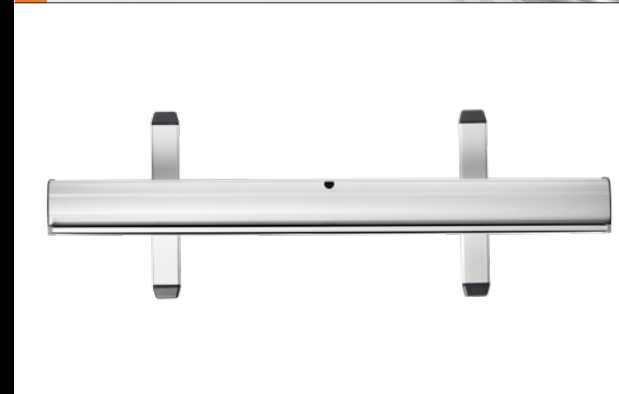

## Roll-Banner Plus

### EN

- Modern top rail (1)
- Padded bag with braces and zipper (2)
- Aluminium feet with black caps
- Reinforced pole holder (3)
- Extra long galvanized steel plate on bottom (4)

### DE

- Modern Oberprofil (1)
- Verstärkte Tasche mit Innenfutter und Reißverschluss (2)
- Aluminiumfüße mit schwarzen Kapfen
- Verstärkte Stangenhalterung (3)
- Extra lange verzinkte Stahlplatte auf der Unterseite (4)

### NL

- Modern bovenprofiel (1)
- Tas met verstevigingen en binnenvoering met ritssluiting (2)
- Aluminium voeten met zwarte kapjes
- Versterkte paalhouder (3)
- Extra lange gegalvaniseerde staalplaat op bodem (4)

### FR

- Rail moderne (1)
- Sac renforcé avec doublure et fermeture éclair (2)
- Pieds en aluminium avec embouts noirs
- Support-mât renforcé (3)
- Plateau acier galvanisé extra long au dessous (4)

### ES

- Perfil superior de diseño moderno (1)
- Bolsa acolchada y reforzada con cremallera (2)
- Pie de aluminio con caperuzas negras
- Soporte de mástil reforzado (3)
- Chapa extra larga de acero galvanizado en la parte de abajo (4)

Single piece cardboard packaging included

Art. nr.	Graphic		Specs				Package <i>See fig. 1a on page 3</i>					Pallet capacity <i>See fig. 2a on page 3</i>	
	W	H	Feet	Poles	KG	Steel plate	W	H	D	KG	⊗ in ⊙	Euro	Industrial
RBPL040	40	200	1	1	1,6	5	37	69	26	12	6	162	198
RBPL060	60	200	2	1	2,2	37	37	69	26	15	6	162	198
RBPL080	80	200	2	1	2,2	52	37	88	26	19	6	120	138
RBPL085	85	200	2	1	2,8	57	37	93	26	20	6	120	138
RBPL100	100	200	2	1	3,2	72	37	108	26	22	6	108	120
RBPL120	120	200	2	2	4,1	92	26	128	26	20	4	48	48
RBPL150	150	200	2	2	4,8	122	26	158	26	24	4	48	48

All sizes in cm.

Max. pcs. on pallet



Classic range

# Roll-Banner Evolution

'Elegant and stylish'

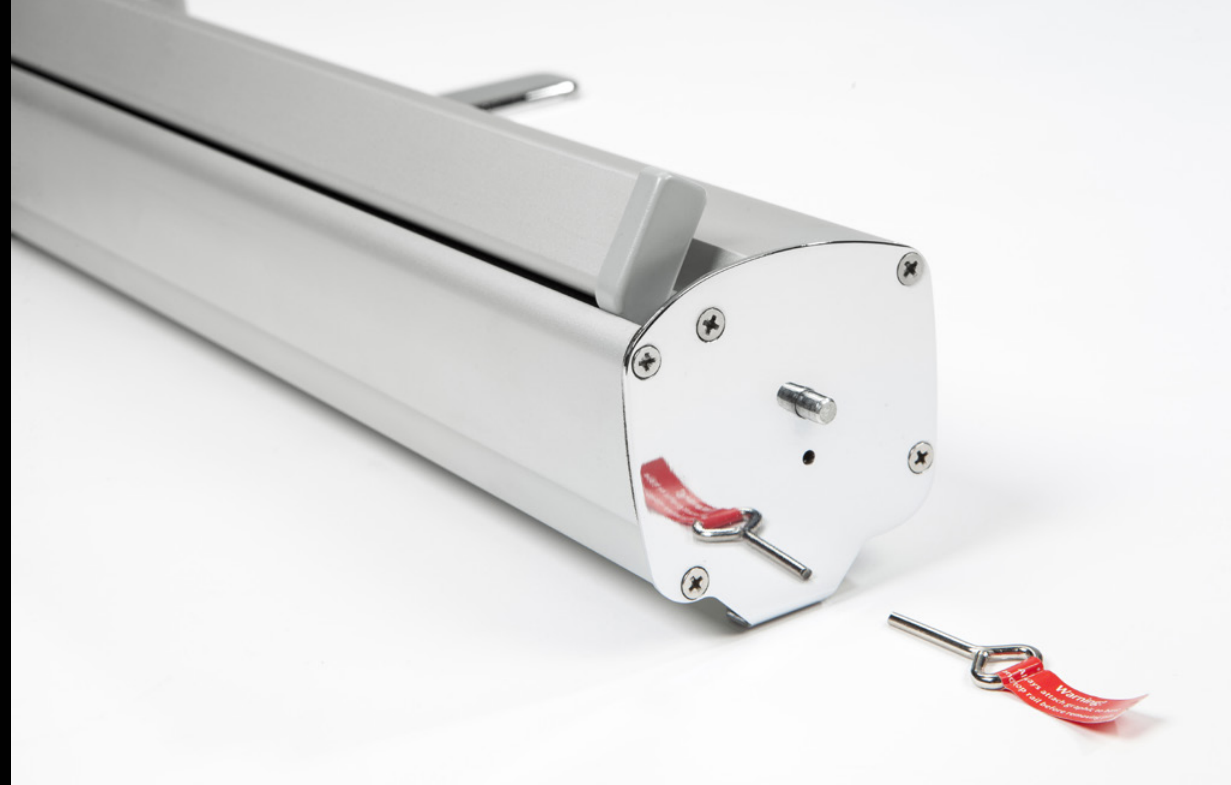

## Roll-Banner Evolution

EN

- Cassette with chromed side caps and chromed steel foot (1)
- Heavy duty top rail (2)
- Telescopic pole (3)
- Padded bag with zipper over full length (4)

DE

- Kassette mit verchromten Seitenkappen und verchromter Stahlfuß (1)
- Robustes Oberprofil (2)
- Teleskopstange (3)
- Verstärkte Tasche mit Innenfutter und Reißverschluss über die ganze Taschenlänge (4)

NL

- Cassette met verchromde zijkant en verchromde stalen voet (1)
- Robuust bovenprofiel (2)
- Telescopische paal (3)
- Tas met verstevigingen en binnenvoering met ritssluiting over volledige lengte (4)

FR

- Cassette avec côtés chromés et pied en acier chromés (1)
- Rail robuste (2)
- Mât télescopique (3)
- Sac renforcé avec doublure et fermeture éclair sur toute la longueur (4)

FR

- carcasa con laterales cromados y pie de acero cromado (1)
- Perfil superior robusto (2)
- Mástil telescópico (3)
- Bolsa acolchada y reforzada con cremallera a todo el largo (4)

✓ Single piece cardboard packaging included

Art. nr.

RBEVO085  
 RBEVO100  
 RBEVO120  
 RBEVO150

All sizes in cm.

### Graphic

W	H
85	160 - 220
100	160 - 220
120	160 - 220
150	160 - 220

### Specs

Feet	Poles	KG
1	1	3,6
1	1	4,1
2	1	4,9
2	2	6

### Package See fig. 1a on page 3

W	H	D	KG	⊗ in ⊕
41	97	29	25	6
41	112	29	27	6
29	132	29	23	4
28	160	15	15	2

### Pallet capacity See fig. 2a on page 3

Euro	Industrial
96	108
84	96
48	48
46	48

Max. pcs. on pallet

Classic range

# Roll-Banner Massive



## Roll-Banner **Massive**

### EN

- Heavy duty top rail (1)
- Telescopic pole (2)
- Massive aluminium foot (3)
- Padded bag with zipper over full length (4)

### DE

- Robustes Oberprofil (1)
- Teleskopstange (2)
- Massiver Aluminiumfuß (3)
- Verstärkte Tasche mit Innenfutter und Reißverschluss über die ganze Taschenlänge (4)

### NL

- Robuust bovenprofiel (1)
- Telescopische paal (2)
- Massieve aluminium voet (3)
- Tas met verstevigingen en binnenvoering met ritsluiting over volledige lengte (4)

### FR

- Rail robuste (1)
- Mât télescopique (2)
- Pieds en aluminium massif (3)
- Sac renforcé avec doublure et fermeture éclair sur toute la longueur (4)

### ES

- Perfil superior robusto (1)
- Mástil telescópico (2)
- Ries de aluminio masivo (3)
- Bolsa acolchada y reforzada con cremallera a todo el largo (4)

✓ Single piece cardboard packaging included

Art. nr.

RBMAS085  
RBMAS100  
RBMAS120  
RBMAS150

All sizes in cm.

### Graphic

W H

85	160 - 220
100	160 - 220
120	160 - 220
150	160 - 220

### Specs

Feet Poles KG

1	1	4,1
1	1	5
2	1	6,3
2	2	7,6

### Package *See fig. 1a on page 3*

W H D KG (X) in (Y)

39	97	29	28	6
39	110	29	22	4
26	130	29	26	4
15	160	29	18	2

### Pallet capacity *See fig. 2a on page 3*

Euro Industrial

96	108
84	90
48	48
40	48

Max. pcs. on pallet



Classic range

# Roll-Banner Twin



## Roll-Banner **Twin**

### EN

- Slim and elegant top rail (1)
- Padded bag with zipper over full length (2)

### DE

- Elegantes Oberprofil (1)
- Verstärkte Tasche mit Innenfutter und Reißverschluss über die ganze Taschenlänge (2)

### NL

- Elegant bovenprofiel (1)
- Tas met verstevigingen en binnenvoering met ritssluiting over volledige lengte (2)

### FR

- Rail au design fin et élégant (1)
- Sac renforcé avec doublure et fermeture éclair sur toute la longueur (2)

### ES

- Perfil superior de diseño delgado y elegante (1)
- Bolsa acolchada y reforzada con cremallera a todo el largo (2)

✓ Single piece cardboard packaging included

Art. nr.

RBTW085  
RBTW100

All sizes in cm.

### Graphic

W	H
85	200
100	200

### Specs

Poles	KG
1	4,6
1	5,2

### Package

See fig. 1a on page 3

W	H	D	KG	ⓧ in Ⓨ
47	99	25	20	4
47	114	25	22	4

### Pallet capacity

See fig. 2a on page 3

Euro	Industrial
56	72
52	68

Max. pcs. on pallet

High-end range

# Roll-Banner Premium

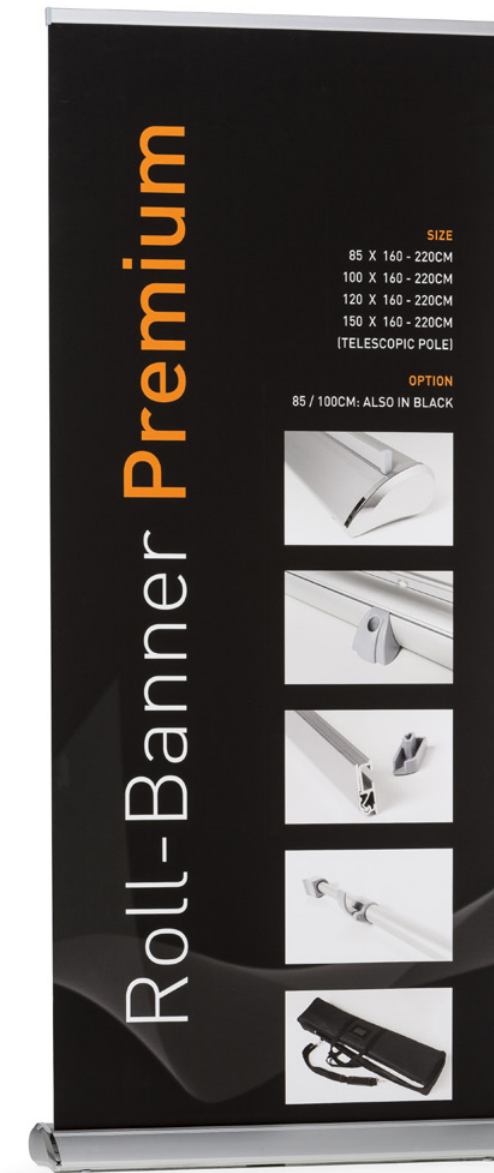
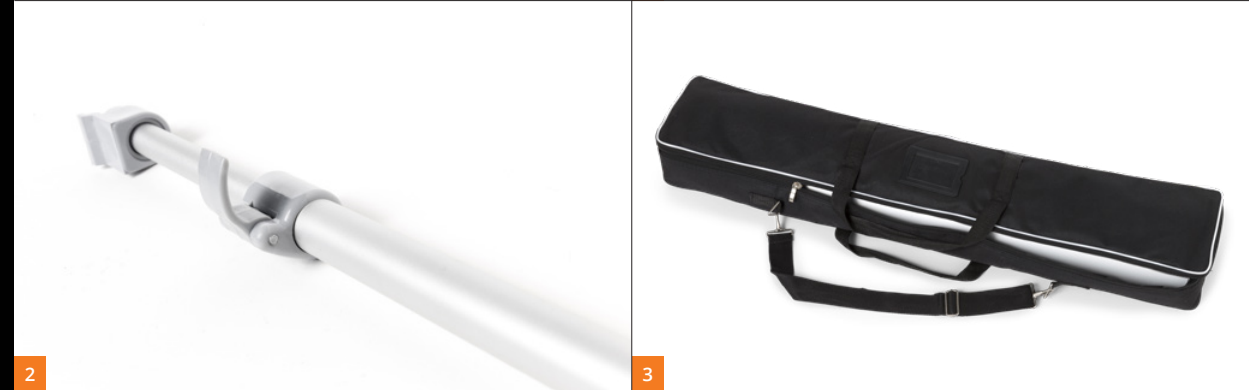
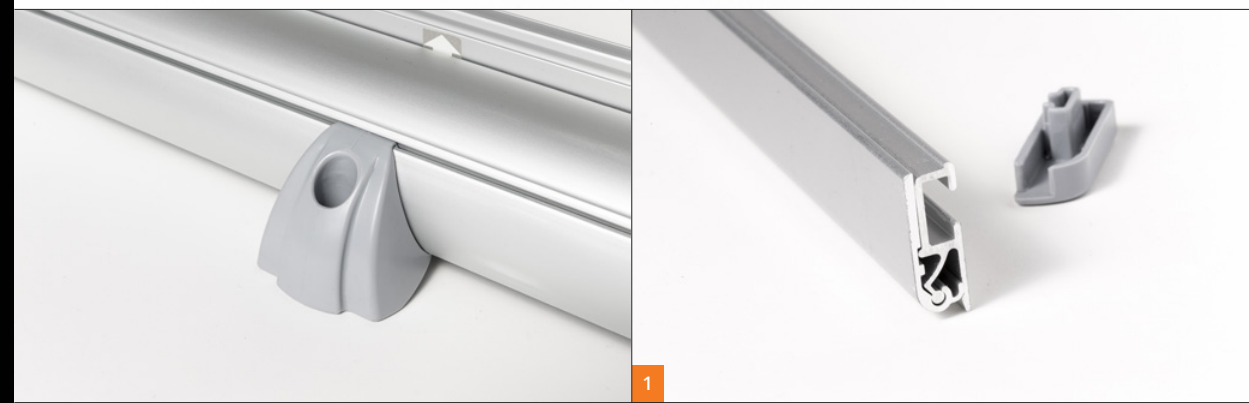

## Roll-Banner Premium

### EN

- Cassette with chromed side caps
- Heavy duty top rail (1)
- Telescopic pole (2)
- Levelling screws on bottom side
- Padded bag with zipper over full length (3)

### DE

- Kassette mit verchromten Seitenkappen
- Robustes Oberprofil (1)
- Teleskopstange (2)
- Stellfüße an der Unterseite
- Verstärkte Tasche mit Innenfutter und Reißverschluss über die ganze Taschenlänge (3)

### NL

- Cassette met verchromde zijkant
- Robuust bovenprofiel (1)
- Telescopische paal (2)
- Stelvoeten aan onderzijde
- Tas met verstevigingen en binnenvoering met ritssluiting over volledige lengte (3)

### FR

- Cassette avec côtés chromés
- Rail robuste (1)
- Mât télescopique (2)
- Pieds réglables
- Sac renforcé avec doublure et fermeture éclair sur toute la longueur (3)

### ES

- Carcasa con laterales cromados
- Perfil superior robusto (1)
- Mástil telescópico (2)
- Pies regulables
- Bolsa acolchada y reforzada con cremallera a todo el largo (3)

✓ Single piece cardboard packaging included

Art. nr.	Colour	Graphic		Specs		Package <i>See fig. 1a on page 3</i>					Pallet capacity <i>See fig. 2a on page 3</i>	
		W	H	Poles	KG	W	H	D	KG	(X) in (Y)	Euro	Industrial
RBP085	●	85	160-220	1	5,7	44	98	24	26	4	56	80
RBP100	●	100	160-220	1	6,8	44	114	24	29	4	52	72
RBP120	●	120	160-220	1	8,3	22	136	24	18	2	30	40
RBP150	●	150	160-220	2	10	22	164	24	21	2	30	40
RBPB085	●	85	160-220	1	5,7	44	98	24	26	4	56	80
RBPB100	●	100	160-220	1	6,8	44	114	24	29	4	52	72

*All sizes in cm.*

*Max. pcs. on pallet*



High-end range

# Roll-Banner Deluxe

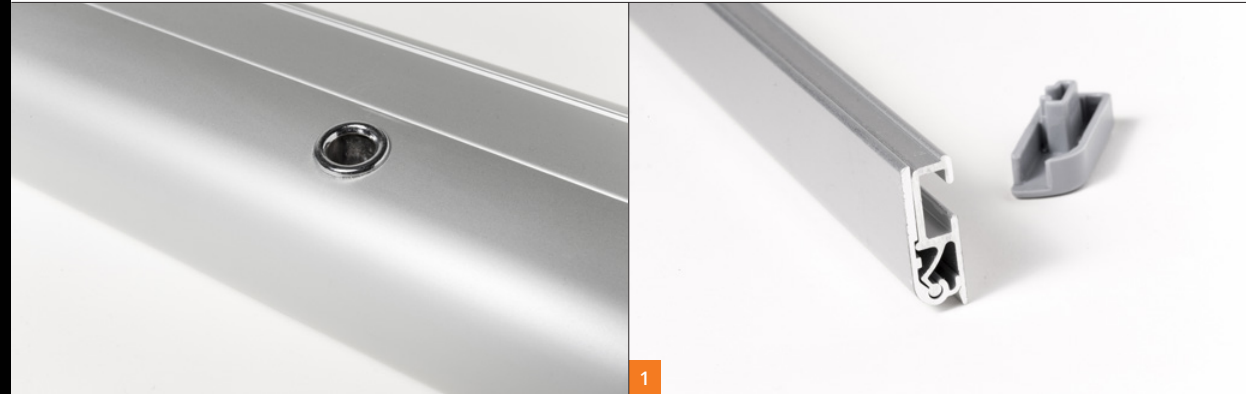

Roll-Banner **Deluxe**

**EN**

- Cassette with chromed side caps
- Heavy duty top rail (1)
- Adjustable telescopic pole with height indication (2)
- Bottom snap rail with adjustable spring tension (3)
- Padded bag with zipper over full length (4)

**DE**

- Kassette mit verchromten Seitenkappen
- Robustes Oberprofil (1)
- Verstellbare Teleskopstange mit Höhenangabe (2)
- Untere Klemmschiene mit einstellbarer Federspannung (3)
- Verstärkte Tasche mit Innenfutter und Reißverschluss über die ganze Taschenlänge (4)

**NL**

- Cassette met verchromde zijkant
- Robuust bovenprofiel (1)
- Verstellbare telescopische paal met hoogteaanduiding (2)
- Onderzijde klemprofiel met verstelbare veerspanning (3)
- Tas met verstevigingen en binnenvoering met ritssluiting over volledige lengte (4)

**FR**

- Cassette avec côtés chromés
- Rail robuste (1)
- Mât télescopique ajustable avec indication de la hauteur (2)
- Rail inférieur à clip avec tension à ressort ajustable (3)
- Sac renforcé avec doublure et fermeture éclair sur toute la longueur (4)

**ES**

- Carcasa con laterales cromados
- Perfil superior robusto (1)
- Poste telescópico con indicación de altura (2)
- Perfil de sujeción inferior con ressort ajustable (3)
- Bolsa acolchada y reforzada con cremallera a todo el largo (4)

✓ Single piece cardboard packaging included

Art. nr.	Graphic		Specs		Package <i>See fig. 1a on page 3</i>					Pallet capacity <i>See fig. 2a on page 3</i>	
	W	H	Poles	KG	W	H	D	KG	⊗ in ⊙	Euro	Industrial
RBL085	85	160-225	1	5,3	36	99	29	19	3	48	66
RBL100	100	160-225	1	6	36	113	29	21	3	42	48
RBL120	120	160-225	1	6,6	27	135	25	18	2	24	32

*All sizes in cm.*

*Max. pcs. on pallet*

High-end range

# Roll-Banner Double

'Twice the attention'



## Roll-Banner Double

### EN

- Cassette with chromed side caps
- Modern and heavy duty top rail (1)
- Minimised graphic distance (2)
- Padded bag with zipper over full length (3)

### DE

- Kassette mit verchromten Seitenkappen
- Modernes und robustes Oberprofil (1)
- Minimaler Grafikabstand (2)
- Verstärkte Tasche mit Innenfutter und Reißverschluss über die ganze Taschenlänge (3)

### NL

- Cassette met verchromde zijkant
- Modern en robuust bovenprofiel (1)
- Minimale afstand tussen prints (2)
- Tas met verstevigingen en binnenvoering met ritssluiting over volledige lengte (3)

### FR

- Cassette avec côtés chromés
- Rail moderne et robuste (1)
- Distance minimale entre les visuels (2)
- Sac renforcé avec doublure et fermeture éclair sur toute la longueur (3)

### ES

- Carcasa con laterales cromados
- Perfil superior robusto y moderno (1)
- Distancia mínima entre los visuales (2)
- Bolsa acolchada y reforzada con cremallera a todo el largo (3)

✓ Single piece cardboard packaging included

Art. nr.	Graphic		Specs		Package <i>See fig. 1a on page 3</i>					Pallet capacity <i>See fig. 2a on page 3</i>	
	W	H	Poles	KG	W	H	D	KG	⊗ in ⊙	Euro	Industrial
RBD085	85	200	1	6,6	36	99	29	24	3	48	60
RBD100	100	200	1	7,6	36	113	29	28	3	42	51
RBD120	120	200	1	8,7	27	135	25	22	2	24	32

*All sizes in cm.*

*Max. pcs. on pallet*



Special range

# Roll-Banner Extreme

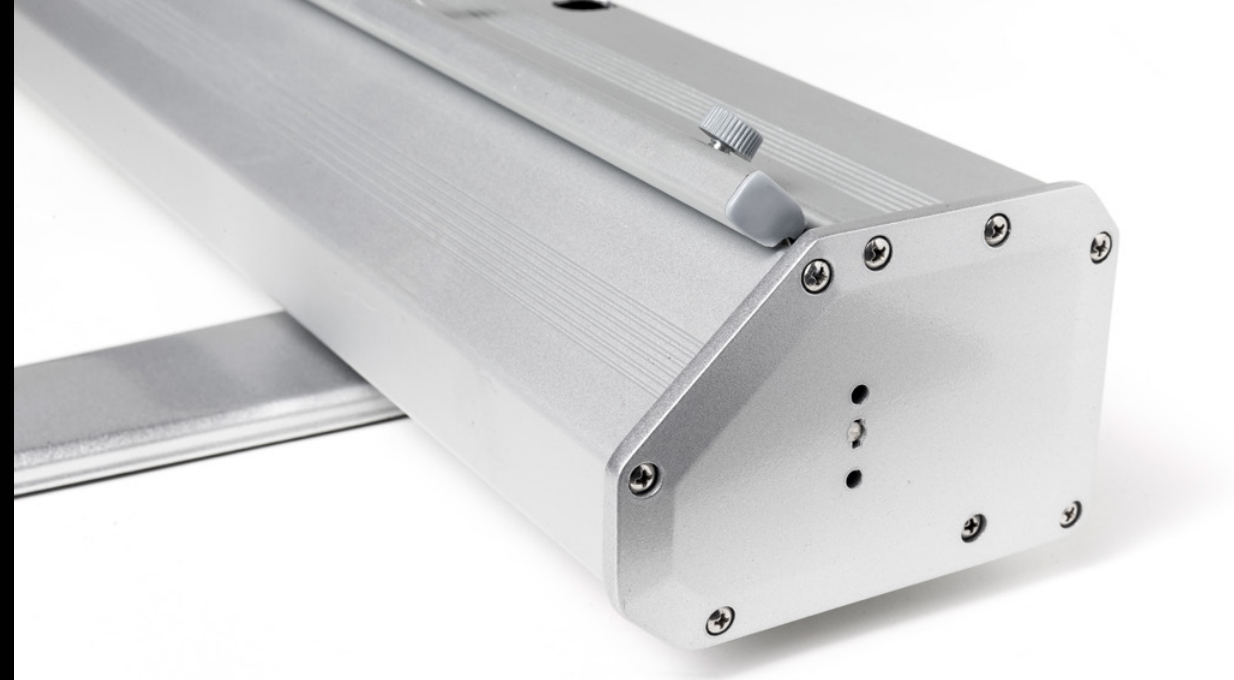

1: Patented



2



4



3



## Roll-Banner **Extreme**

### EN

- Solid patented aluminium side caps (1)
- Top rail with clamping screws (2)
- Adjustable telescopic poles with height indication (3)
- Padded bag with zipper over full length (4)

### DE

- Massive patentierte Aluminiumseitenkappen (1)
- Oberprofil mit Klemverschraubung (2)
- Verstellbare Teleskopstangen mit Höhenangabe (3)
- Verstärkte Tasche mit Innenfutter und Reißverschluss über die ganze Taschenlänge (4)

### NL

- Massieve gepatenteerde aluminium zijkappen (1)
- Bovenprofiel met klem Schroeven (2)
- Verstelbare telescopische palen met hoogteaanduiding (3)
- Tas met verstevigingen en binnenvoering met ritssluiting over volledige lengte (4)

### FR

- Côtes robustes d'aluminium brevetés (1)
- Rail avec vis à pince (2)
- Mâts télescopiques avec indicateur de la hauteur (3)
- Sac renforcé avec doublure et fermeture éclair sur toute la longueur (4)

### ES

- Tapas de aluminio sólido patentados (1)
- Perfil superior con tornillos de apriete (2)
- Postes telescópicos con indicación de altura (3)
- Bolsa acolchada y reforzada con cremallera a todo el largo (4)

✓ Single piece cardboard packaging included

Art. nr.

RBEX150  
RBEX200

All sizes in cm.

### Graphic

W	H
150	170-270
200	170-300

### Specs

Feet	Poles	KG
2	2	9,8
2	2	11,6

### Package See fig. 1a on page 3

W	H	D	KG	⊗ in ⊕
33	162	18	21	2
18	210	15	13	1

### Pallet capacity See fig. 2a on page 3

Euro	Industrial
28	36
30	36

Max. pcs. on pallet

Special range

# Roll-Banner Mini



## Roll-Banner **Mini**

### EN

- Cassette with chromed side caps
- Top rail with TESA adhesive tape (1)
- Chromed steel pole (2)
- Single piece cardboard packaging (3)

### DE

- Kassette mit verchromten Seitenkappen
- Oberprofil mit doppelseitigem TESA Klebeband (1)
- Verchromte Stahlstange (2)
- In Einzelkartonagen verpackt (3)

### NL

- Cassette met verchromde zijkant
- Bovenprofiel met zelfklevende TESA tape (1)
- Verchromde stalen paal (2)
- Individuele kartonnen verpakking (3)

### FR

- Cassette avec côtés chromés
- Rail supérieur avec adhésif TESA (1)
- Perche chromée en acier (2)
- Emballage carton individuel par pièce (3)

### ES

- Carcasa con laterales cromados
- Perfil superior con cinta autoadhesiva TESA (1)
- Barra de acero cromado (2)
- Envase en cartón individual (3)

✓ Single piece cardboard packaging included

Art. nr.

RBMA4  
RBMA3

All sizes in cm.

### Graphic

W	H
21	29,7
29,7	42

### Specs

Poles	KG
1	0,3
1	0,4

### Package See fig. 1a on page 3

W	H	D	KG	⊗ in ⊙
28	47	12	4	10
38	47	12	5	10

### Pallet capacity See fig. 2a on page 3

Euro	Industrial
960	1160
800	1000

Max. pcs. on pallet



# Banner Stands

L-Banner Quick	80
L-Banner Telescopic	82
X-Banner Budget	84
X-Banner Premium	86
Panel Base Aluminium	88

# L-Banner Quick

'Basic and quick solution'

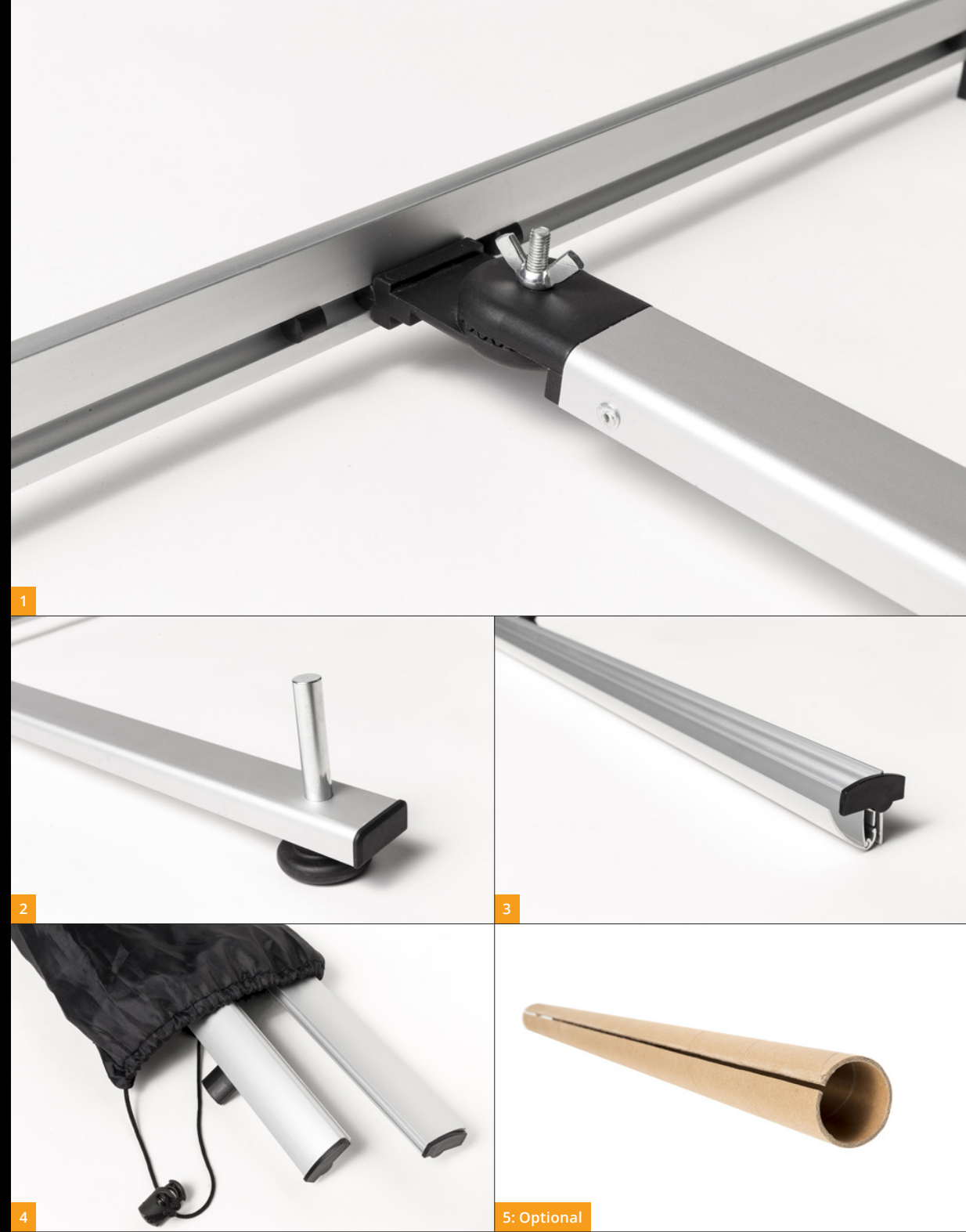

## L-Banner Quick

### EN

- Twist foot with screw connection (1)
- Bottom pole holder (2)
- Snap rail on top and bottom (3)
- Basic transporter bag (4)
- **Optional:** Cardboard tube for protection prints (5)

### DE

- Drehfuß mit Schraubanschluß (1)
- Stangenhalterung unten (2)
- Oben und unten Klemmschiene (3)
- Einfache Transporttasche (4)
- **Optionale:** Papprolle zum Schutz der Drucke (5)

### NL

- Draaivoet met schroefverbinding (1)
- Onderkant paalhouder (2)
- Klemprofiel boven en onder (3)
- Simpele transporttas (4)
- **Optioneel:** Kartonnen koker voor bescherming prints (5)

### FR

- Pied pivotable vissé (1)
- Support mât inférieur (2)
- Rail à clips en bas et en haut (3)
- Sac de transport basique (4)
- **Optionnel :** Tube de rangement en carton afin de protéger les visuels (5)

### ES

- Pie giratorio con conexión roscada (1)
- Soporte de poste inferior (2)
- Perfil abatible superior e inferior (3)
- Bolsa de transporte básica (4)
- **Opcional:** Tubo de cartón para la protección de los visuales (5)

### Optional cardboard tube (5)

Art. nr.	Product
BT080	Banner Tube 80cm
BT100	Banner Tube 100cm

Art. nr.	Graphic		Package <i>See fig. 1a on page 3</i>					Pallet capacity <i>See fig. 2a on page 3</i>	
	W	H	W	H	D	KG	(X) in (Y)	Euro	Industrial
LBQ080	80	200	26	87	27	21	15	360	405
LBQ100	100	200	26	103	27	24	15	240	360

*All sizes in cm.*

*Max. pcs. on pallet*



# L-Banner Telescopic



1

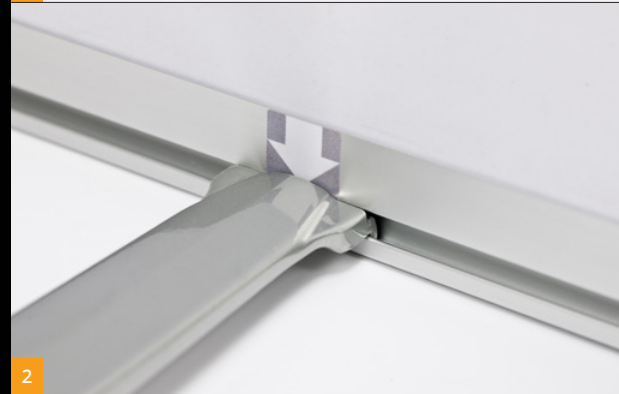

2



3

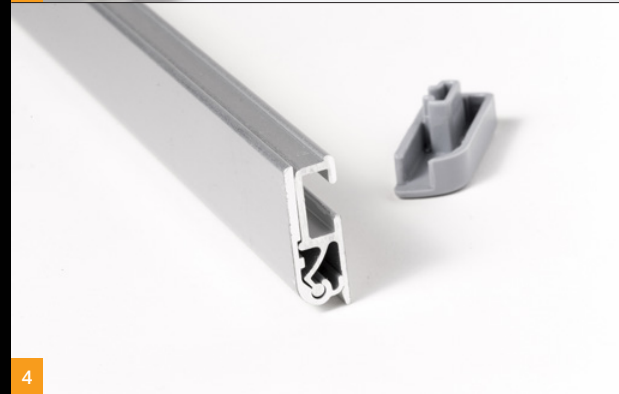

4



5



6: Optional

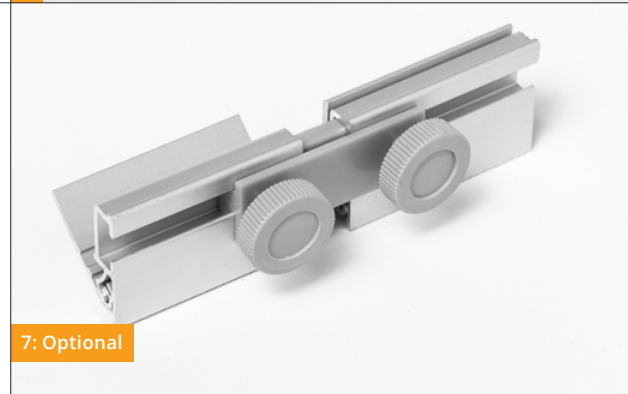

7: Optional



Optional cardboard tube (6)

Art. nr.	Product
BT080	Banner Tube 80cm
BT085	Banner Tube 85cm
BT100	Banner Tube 100cm

Optional connector (7)

Art. nr.	Product
LBC	L-Banner Connector

L-Banner **Telescopic**

EN

- Luxurious massive aluminium foot (1)
- Snap rail on top and bottom (2)
- Telescopic pole (3)
- Modern and heavy duty top rail (4)
- 3 compartment tube bag (5)
- **Optional:** Cardboard tube for protection prints (6)
- **Optional:** L-Banner connector (7)

DE

- Formschöner massiver Aluminiumfuß (1)
- Oben und unten Klemmschiene (2)
- Teleskopstange (3)
- Modernes und robustes Oberprofil (4)
- Köchertasche mit 3 Fächern (5)
- **Optional:** Papprolle zum Schutz der Drucke (6)
- **Optional:** L-Banner connector (7)

NL

- Luxe massieve aluminium voet (1)
- Klemprofiel boven en onder (2)
- Telescopische paal (3)
- Modern en robuust bovenprofiel (4)
- 3 compartimenten kokertas (5)
- **Optioneel:** Kartonnen koker voor bescherming prints (6)
- **Optioneel:** L-Banner connector (7)

FR

- Pied design luxueux et massif en aluminium (1)
- Rail à clips en haut et en bas (2)
- Mât télescopique (3)
- Rail moderne et robuste (4)
- Sac pour le tube doté de 3 compartiments (5)
- **Optionnel :** Tube de rangement en carton afin de protéger les visuels (6)
- **Optionnel :** L-Banner connector (7)

ES

- Pie lujoso y masivo en aluminio (1)
- Perfil abatible superior e inferior (2)
- Mástil telescópico (3)
- Perfil superior robusto y moderno (4)
- Bolsa tubular con 3 compartimientos (5)
- **Opcional:** Tubo de cartón para la protección de los visuales (6)
- **Opcional:** L-Banner connector (7)

76

Art. nr.

LB080  
LB085  
LB100

Graphic

W	H
80	160-220
85	160-220
100	160-220

All sizes in cm.

Package See fig. 1a on page 3

W	H	D	KG	⊗ in ⊙
35	90	37	25	10
35	95	37	26	10
35	110	37	29	10

Pallet capacity See fig. 2a on page 3

Euro	Industrial
140	140
120	120
120	120

Max. pcs. on pallet

# X-Banner Budget

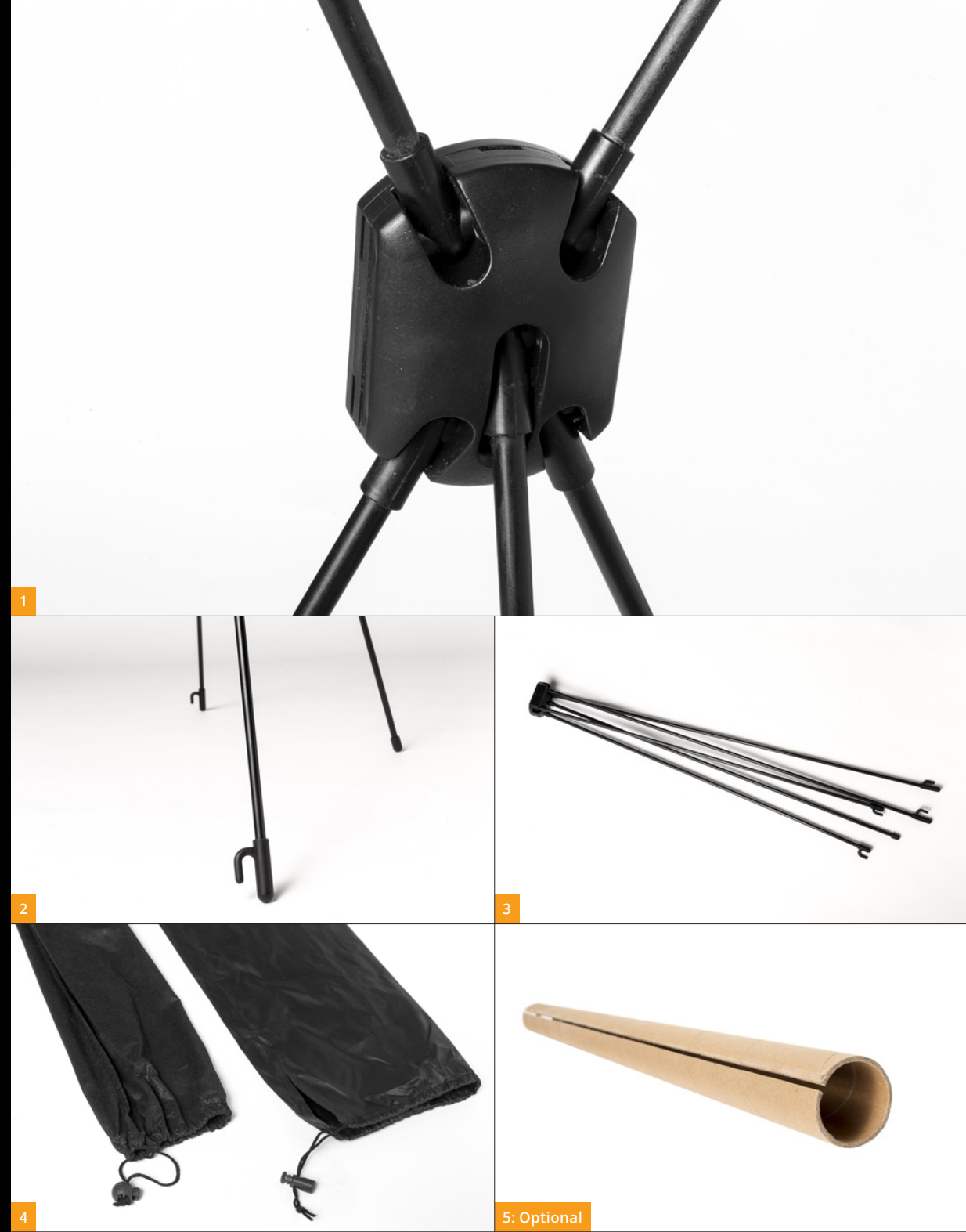

## X-Banner Budget

- EN**
- Center connector (1)
  - Low position bottom hook (2)
  - Compact storage (3)
  - Protection pouch included (left), transporter bag is optional (right) (4)
  - **Optional:** Cardboard tube for protection prints (5)

- DE**
- Zentraler Verbindungspunkt (1)
  - Niedrig positionierter Haken unten (2)
  - Kompakt zu lagern (3)
  - Schutztasche inklusive (links), Transporttasche ist optional (rechts) (4)
  - **Optional:** Papprolle zum Schutz der Drucke (5)

- NL**
- Centraal verbindingpunt (1)
  - Laag gepositioneerde onderhaak (2)
  - Compact op te bergen (3)
  - Inclusief beschermende hoed (links), transporttas is optioneel (rechts) (4)
  - **Optioneel:** Kartonnen koker voor bescherming prints (5)

- FR**
- Connecteur central (1)
  - Crochets en position basse (2)
  - Rangement compact (3)
  - Sac de protection inclus (à gauche), sac de transport en option (à droite) (4)
  - **Optionnel :** Tube de rangement en carton afin de protéger les visuels (5)

- ES**
- Conector central (1)
  - Gancho inferior (2)
  - Almacenaje compacto (3)
  - Funda de protección incluida (izquierda), la bolsa de transporte es opcional (derecha) (4)
  - **Opcional:** Tubo de cartón para la protección de los visuales (5)

Optional cardboard tube (5)

Art. nr.	Product
BT060	Banner Tube 60cm
BT080	Banner Tube 80cm

Art. nr.	Graphic		Package <i>See fig. 1a on page 3</i>					Pallet capacity <i>See fig. 2a on page 3</i>	
	W	H	W	H	D	KG	⊗ in ⊙	Euro	Industrial
XBB60-160	60	160	30	96	40	16	40	480	720
XBB80-180	80	180	30	106	40	16	40	480	720
XBB80-200	80	200	30	116	40	16	40	480	720

*All sizes in cm.*

*Max. pcs. on pallet*



# X-Banner Premium

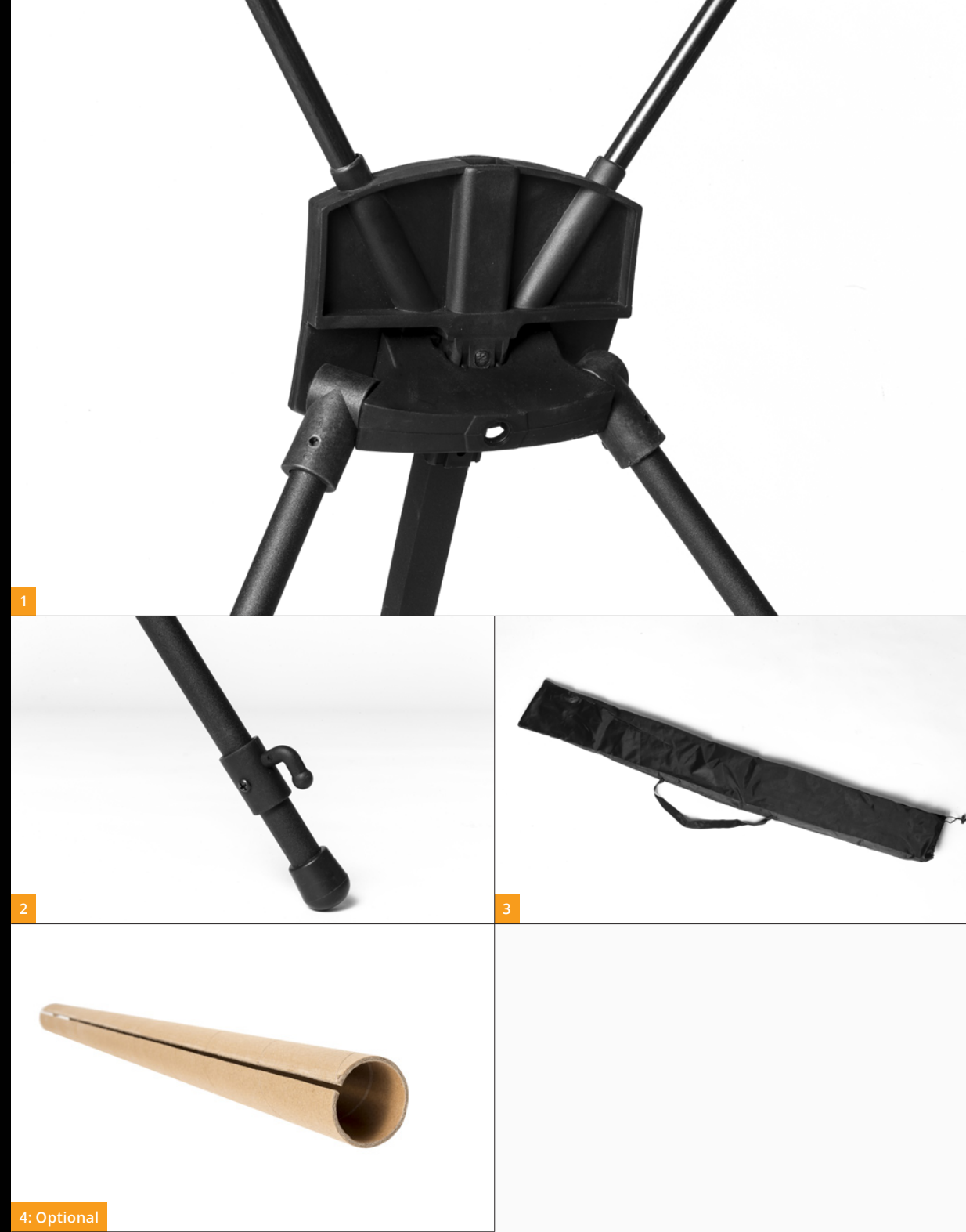

1

2

3

4: Optional



## X-Banner Premium

### EN

- Aluminium tripod with fiber tops
- Center connector (1)
- Low position bottom hook (2)
- Transporter bag (3)
- **Optional:** Cardboard tube for protection prints (4)

### DE

- Aluminium-Stativ mit Fiberglasstangen oben
- Zentraler Verbindungspunkt (1)
- Niedrig positionierter Haken unten (2)
- Transporttasche (3)
- **Optioneel:** Papprolle zum Schutz der Drucke (4)

### NL

- Aluminium driepoot met fiberglas toppalen
- Centraal verbindingpunt (1)
- Laag gepositioneerde onderhaak (2)
- Transporttas (3)
- **Optioneel:** Kartonnen koker voor bescherming prints (4)

### FR

- Trépied aluminium avec mâts supérieurs en fibre de verre
- Connecteur central (1)
- Crochets en position basse (2)
- Sac pour transport (3)
- **Optionnel :** Tube de rangement en carton afin de protéger les visuels (4)

### ES

- Trípode de aluminio con tapas superiores de fibra de vidrio
- Conector central (1)
- Gancho inferior (2)
- Bolsa de transporte (3)
- **Opcional:** Tubo de cartón para la protección de los visuales (4)

### Optional cardboard tube (4)

Art. nr.	Product
BT060	Banner Tube 60cm
BT080	Banner Tube 80cm
BT100	Banner Tube 100cm
BT120	Banner Tube 120cm

### Art. nr.

XBP060  
XBP080  
XBP100  
XBP120

All sizes in cm.

### Graphic

W	H
60	160
80	180
100	200
120	200

### Package See fig. 1a on page 3

W	H	D	KG	⊗ in ⊙
20	101	38	20	15
20	121	38	22	15
22	140	38	17	10
22	140	38	18	10

### Pallet capacity See fig. 2a on page 3

Euro	Industrial
330	450
300	225
100	120
100	120

Max. pcs. on pallet

# Panel Base Aluminium

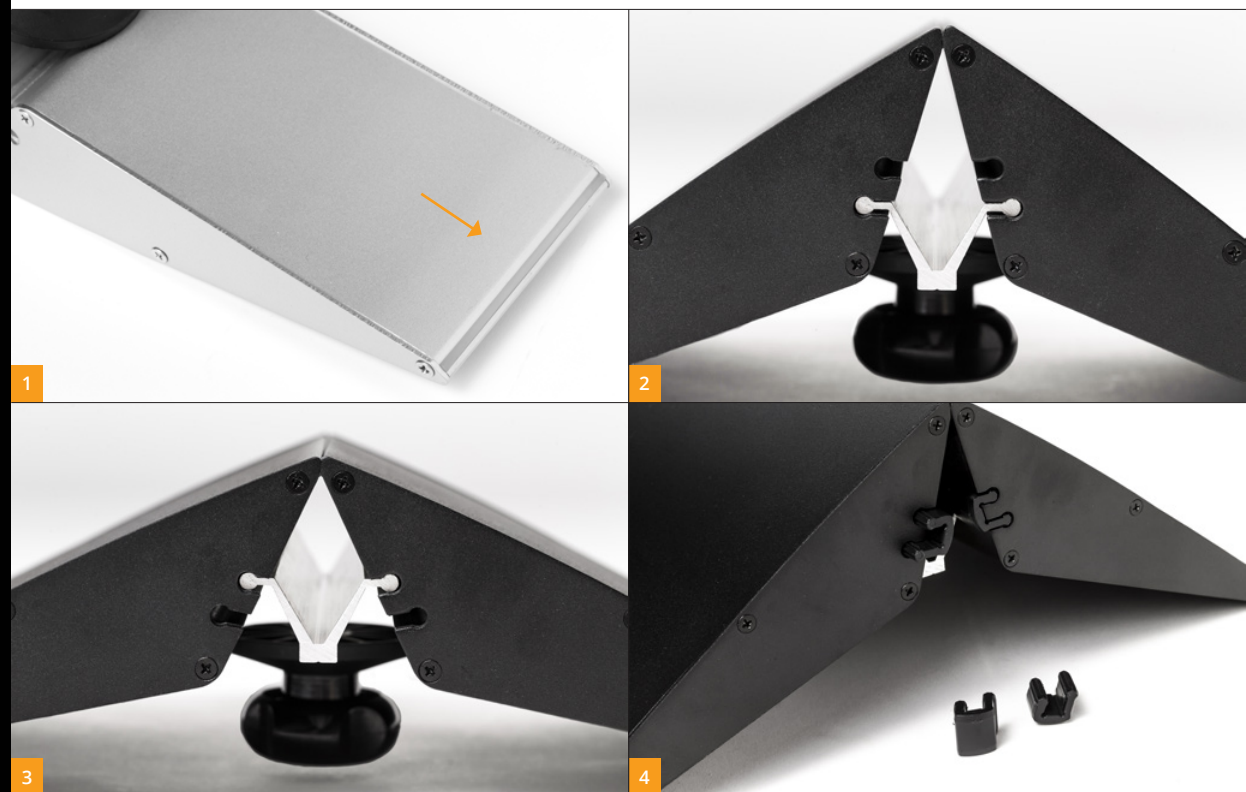

## Panel Base Aluminium

### EN

- Stable aluminium base
- Anti-slip silicon (1)
- Stand 1: panel thickness 3 - 18 mm (2)
- Stand 2: panel thickness 18 - 26 mm (3)
- Stoppers (4)

### DE

- Stabiler Aluminiumfuß
- Antirutsch-Silikon (1)
- Position 1: Wandstärke 3 - 18 mm (2)
- Position 2: Wandstärke 18 - 26 mm (3)
- Sicherheitsklammern (4)

### NL

- Stabiele aluminium voet
- Antislip silicone (1)
- Stand 1: paneeldikte 3 - 18 mm (2)
- Stand 2: paneeldikte 18 - 26 mm (3)
- Stopdopjes (4)

### FR

- Base en aluminium stable
- Silicone antidérapant (1)
- Stand 1 : épaisseur du panneau 3 - 18 mm (2)
- Stand 2 : épaisseur du panneau 18 - 26 mm (3)
- Calles (4)

### ES

- Base de aluminio estable
- Silicona antideslizante (1)
- Posición 1: grosor del panel 3 - 18 mm (2)
- Posición 2: grosor del panel 18 - 26 mm (3)
- Tapones (4)

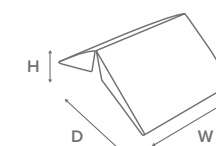

Art. nr.

Colour

PBAS10  
PBAS30  
PBAS50

●  
●  
●

PBAB10  
PBAB30  
PBAB50

●  
●  
●

All sizes in cm.

### Dimensions

W	H	D
10	14	38
30	14	38
50	14	38

### Package See fig. 1a on page 3

W	H	D	KG	⊗ in ⊙
32	25	41	6	4
32	33	41	7	2
32	53	41	10	2

### Pallet capacity See fig. 2a on page 3

Euro	Industrial
192	188
72	108
48	72

Max. pcs. on pallet





# Lighting Banner LED

'Enlight your banner'

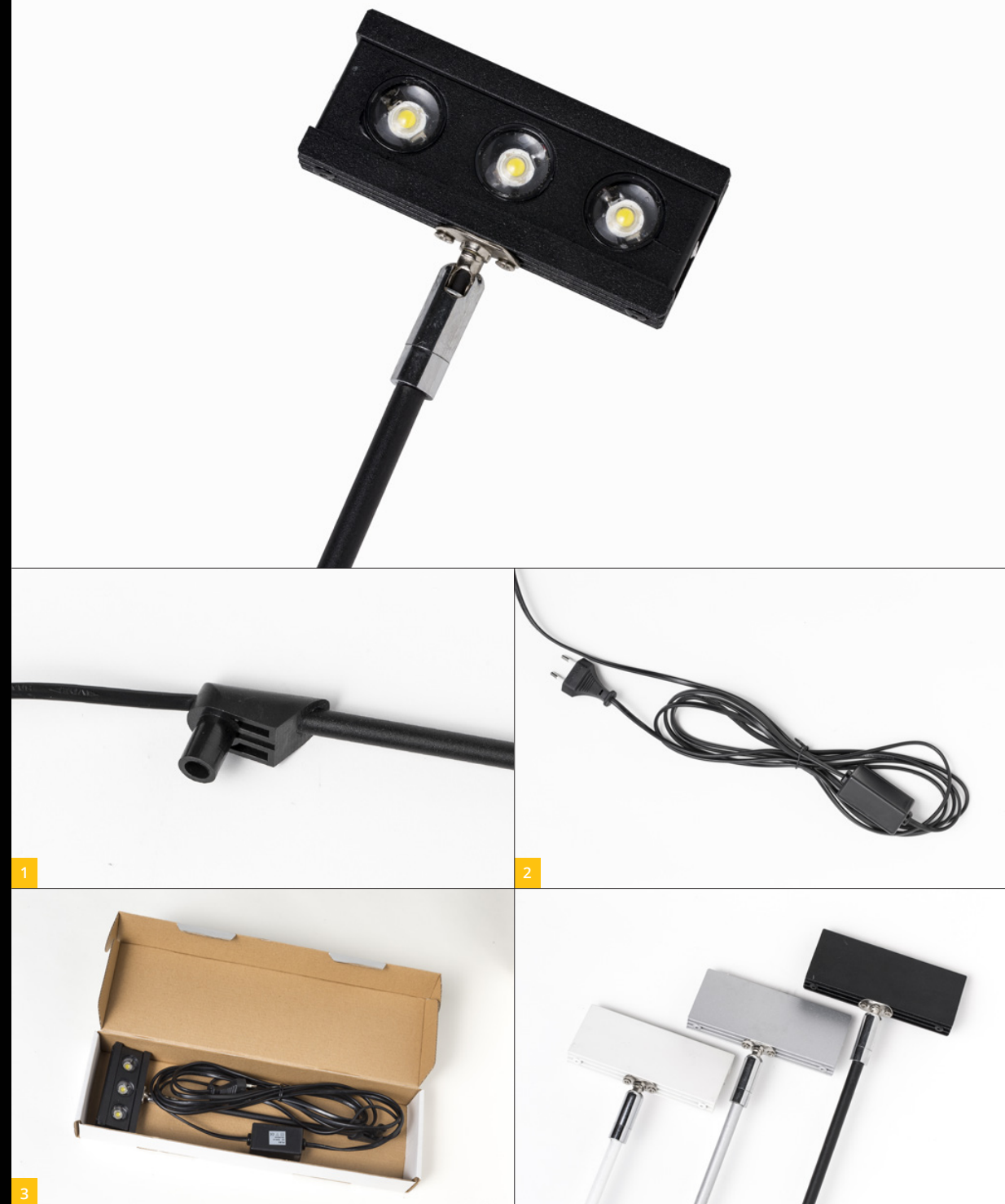

## Lighting **Banner LED**

### EN

- Three bright power LEDs
- Powder coating available in black, silver or white
- Connection part suitable on all our Roll-Banners (1)
- 3 m power cable (2)
- Single piece cardboard packaging (3)

### DE

- Drei helle power LEDs
- Pulverlackbeschichtung verfügbar in schwarz, silber oder weiß
- Verbindungsteil passend auf jeden unserer Roll-Banners (1)
- 3 m Stromkabel (2)
- Einzelstück Kartonverpackung (3)

### NL

- Drie heldere power LEDs
- Poedercoating beschikbaar in zwart, zilver of wit
- Verbindingsdeel passend op al onze Roll-Banners (1)
- 3 m stroomkabel (2)
- Kartonnen stuksverpakking (3)

### FR

- Trois LEDs puissantes
- Recouvert de poudre disponible en noir, argent ou blanc
- Pièce de connexion adaptable sur toutes nos Roll-Banners (1)
- Cable d'alimentation de 3 m (2)
- Emballage par carton individuel (3)

### ES

- Tres LED brillantes
- Lacado disponible en negro, plata o blanco
- Acoplamiento para todos nuestros Roll-Banners (1)
- Cable de alimentación de 3 m (2)
- Envase en cartón individual (3)

**Colour temperature** 4000 kelvin  
**Light brightness** 600 lumen

**Power consumption** 8 watt  
**Equivalent to halogen** 80 watt

**Length power cable** 300 cm  
**Consistent burning hours** 7000 hours

Art. nr. Colour

BLED3B ●  
BLED3S ●  
BLED3W ○

All sizes in cm.

**Package** See fig. 1b on page 3

W	H	D	KG	⊗ in ⊙	⊗ in ⊚
28	87	52	20	10	40
28	87	52	20	10	40
28	87	52	20	10	40



## Lighting

# Banner Light Halogen



### Banner Light Halogen 35 Watt

#### EN

- 35 watt halogen light
- Suitable for any banner type because of clip
- Bag with zipper (1)

#### DE

- Halogenlampe 35 Watt
- Geeignet für alle Banner-Systeme mittels Universalklemme
- Tasche mit Reißverschluss (1)

#### NL

- 35 watt halogeenlamp
- Geschikt voor iedere banner door klem
- Tas met ritssluiting (1)

#### FR

- Lampe halogène 35 watt
- Adaptable à toutes les bannières grâce au clip
- Sac avec fermeture éclair (1)

#### ES

- Foco halógena 35 vatios
- Adecuado para cualquier tipo de banner con la pinza universal
- Bolsa con cremallera (1)



### Banner Light Halogen 50 Watt

#### EN

- 50 watt halogen light
- Metal casing available in silver or black (1)
- Single piece carton packing (2)

#### DE

- Halogenlampe 50 Watt
- Metallgehäuse verfügbar in silber oder schwarz (1)
- In Einzelkartonagen verpackt (2)

#### NL

- 50 watt halogeenlamp
- Metalen behuizing verkrijgbaar in zilver of zwart (1)
- Kartonnen stuksverpakking (2)

#### FR

- Lampe halogène 50 watt
- Boitier métallique disponible en argent ou noire (1)
- Emballage en carton individuel (2)

#### ES

- Foco halógena 50 vatios
- Carcasa metálica disponible en plata o negro (1)
- Envase en cartón individual (2)



<b>Art. nr.</b>	BLH35
<b>Colour temperature</b>	3000 kelvin
<b>Light brightness</b>	400 lumen
<b>Power consumption</b>	35 watt
<b>Length power cable</b>	280 cm
<b>Consistent burning hours</b>	2000 hours

<b>Art. nr. silver</b>	BLH50S
<b>Art. nr. black</b>	BLH50B
<b>Colour temperature</b>	3000 kelvin
<b>Light brightness</b>	500 lumen
<b>Power consumption</b>	50 watt
<b>Length power cable</b>	350 cm
<b>Consistent burning hours</b>	2000 hours

# Lighting Wall LED 50



Colour temperature	4200 kelvin
Light brightness	1100 lumen
Power consumption	11 watt
Equivalent to halogen	110 watt
Length power cable	350 cm
Consistent burning hours	7000 hours

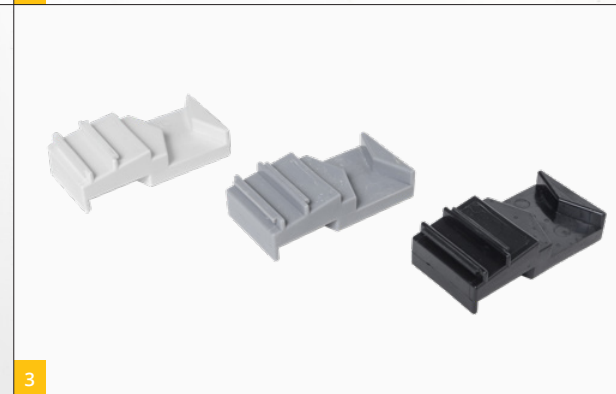

## Lighting Wall LED 50

### EN

- 50 bright LEDs
- Metal casing in white, silver or black
- Single piece cardboard packaging (1)
- 1 m power cable + 2,5 m extension cord (2)
- Including connector suitable on every Pop-Up (3) and connector suitable on several exhibition stands (4)
- **Optional:** Y-cable connects 2 WLED 50. Maximum capacity is 10 x WLED 50 on 1 power socket (5)

### DE

- 50 helle LEDs
- Metallgehäuse verfügbar in weiß, silber oder schwarz
- Einzelstück Kartonverpackung (1)
- 1 m Stromkabel + 2,5 m Verlängerungskabel (2)
- Inklusive Verbindungsteil passend auf jedes Pop-Up (3) und Verbindungsteil passend auf viele Messestände (4)
- **Optional:** Y-Kabel verbindet 2 WLED 50. Maximale Kapazität 10 x WLED 50 auf 1 Strompunkt (5)

### NL

- 50 heldere LEDs
- Metalen behuizing verkrijgbaar in wit, zilver of zwart
- Kartonnen stuksverpakking (1)
- 1 m stroomkabel + 2,5 m verlengkabel (2)
- Inclusief verbingsdeel passend op iedere Pop-Up (3) en verbingsdeel passend op veel beursstands (4)
- **Optioneel:** Y-kabel verbindt 2 WLED 50. Maximale capaciteit is 10 x WLED 50 op 1 aansluitpunt (5)

### FR

- 50 LEDs puissantes
- Boîtier métallique disponible en blanc, argent ou noir
- Emballage par carton individuel (1)
- Câble d'alimentation 1 m + câble d'extension 2,5 m (2)
- Connexion adaptable sur tous les Pop-Up (3) et connexion adaptable sur de nombreux stands de salon (4) inclus
- **Optionnel :** Câble-Y permettant de connecter 2 WLED 50. Capacité maximale de 10 x WLED 50 sur 1 prise (5)

### ES

- 50 LED brillantes
- Carcasa metálica disponible en blanco, plata o negro
- Envase en cartón individual (1)
- Cable de alimentación 1 m + cable de extensión 2,5 m (2)
- Incluido un acoplamiento indicado para todos los Pop-Up (3) y un acoplamiento indicado para múltiples stands (4)
- **Opcional:** Cable-Y conecta 2 WLED 50. Capacidad máximo 10 x WLED 50 en 1 solo enchufe (5)

## Package See fig. 1b on page 3

Art. nr.	Colour	W	H	D	KG	ⓧ in Ⓨ	ⓧ in Ⓩ
WLED50B	●	32	93	56	16	10	30
WLED50S	●	32	93	56	16	10	30
WLED50W	○	32	93	56	16	10	30

All sizes in cm.



# Lighting Wall LED 116

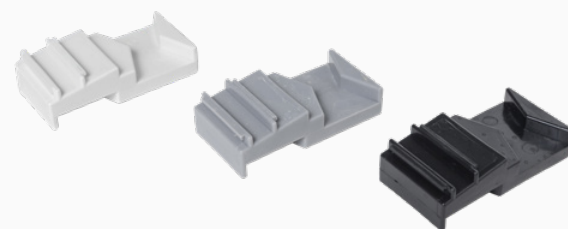

Position power plug: Backside

Colour temperature 4200 kelvin  
Light brightness 2600 lumen

Power consumption 25 watt  
Equivalent to halogen 250 watt

Length power cable 350 cm  
Consistent burning hours 7000 hours



Position power plug: Left & right side

Art. nr.	Colour	Position power plug
WLED1160B-BACK	●	Backside
WLED116B-SIDE	●	Left / Right
WLED116S-BACK	●	Backside
WLED116S-SIDE	●	Left / Right

All sizes in cm.

Package See fig. 1b on page 3

W	H	D	KG	⊗ in ⊕	⊗ in ⊙
34	65	92	22	10	20
34	65	92	22	10	20
34	65	92	22	10	20
34	65	92	22	10	20

## Lighting Wall LED 116

### EN

- 116 bright LEDs
- Metal casing available in silver or black
- Single piece cardboard packaging (1)
- 1 m power cable + 2,5 m extension cord (2)
- Including connector suitable on every Pop-Up (3) and connector suitable on several exhibition stands (4)
- **Important:** Double portal of WLED 116 enables interconnection. Maximum capacity is 10 x WLED 116 on 1 power socket

### DE

- 116 helle LEDs
- Metallgehäuse verfügbar in Silber oder Schwarz
- Einzelstück Kartonverpackung (1)
- 1 m Stromkabel + 2,5 m Verlängerungskabel (2)
- Inklusive Verbindungsteil passend auf jedes Pop-Up (3) und Verbindungsteil passend auf viele Messestände (4)
- **Wichtig:** Doppelter Stromanschluss bietet die Option WLED 116 miteinander zu verbinden. Maximale Kapazität sind 10 x WLED 116 pro Strompunkt

### NL

- 116 heldere LEDs
- Metalen behuizing verkrijgbaar in zilver of zwart
- Kartonnen stuksverpakking (1)
- 1 m stroomkabel + 2,5 m verlengkabel (2)
- Inclusief verbindingsdeel passend op iedere Pop-Up (3) en verbindingsdeel passend op veel beursstands (4)
- **Belangrijk:** Dubbele stekkerpoort biedt optie tot onderlinge verbinding van WLED 116. Maximale capaciteit 10 x WLED 116 op 1 aansluitpunt

### FR

- 116 LEDs puissantes
- Boîtier métallique disponible en blanc, argent ou noir
- Emballage par carton individuel (1)
- Câble d'alimentation 1 m + câble d'extension 2,5 m (2)
- Connexion adaptable sur tous les Pop-Up (3) et connexion adaptable sur de nombreux stands de salon (4) inclus
- **Important :** Double port de connection sur le WLED 116 qui permet une interconnection. Capacité maximale de 10 x WLED 116 sur 1 prise

### ES

- 116 LED brillantes
- Carcasa metálica disponible en plata o negro
- Envase en cartón individual (1)
- Cable de alimentación 1 m + cable de extensión 2,5 m (2)
- Incluido un acoplamiento indicado para todos los Pop-Up (3) y un acoplamiento indicado para múltiples stands (4)
- **Importante:** Doble portal del WLED 116 permite entrelazar. Capacidad máximo 10 x WLED 116 en 1 solo enchufe

Lighting

# Wall Light Halogen

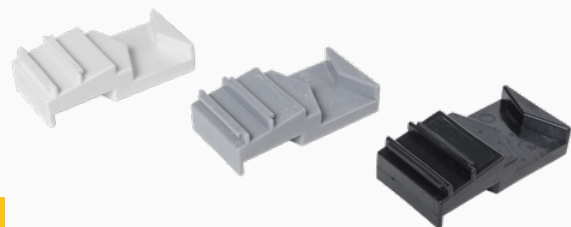

Lighting **Wall Light Halogen 150 Watt**

**EN**

- 150 watt halogen light
- Metal casing available in silver or black
- Single piece cardboard packaging (1)
- Including connector suitable on every Pop-Up (2) and connector suitable on several exhibition stands (3)

**DE**

- Halogenlampe 150 Watt
- Metallgehäuse verfügbar in silber oder schwarz
- Einzelstück Kartonverpackung (1)
- Inklusive Verbindungsteil passend auf jedes Pop-Up (2) und Verbindungsteil passend auf viele Messestände (3)

**NL**

- 150 watt halogeenlamp
- Metalen behuizing verkrijgbaar in zilver of zwart
- Kartonnen stuksverpakking (1)
- Inclusief verbindingsdeel passend op iedere Pop-Up (2) en verbindingsdeel passend op veel beursstands (3)

**FR**

- Lampe halogène 150 watt
- Boîtier métallique disponible en argent ou noir
- Emballage par carton individuel (1)
- Connexion adaptable sur tous les Pop-Up (2) et connexion adaptable sur de nombreux stands de salon (3) inclus

**ES**

- Foco halógena 150 vatios
- Carcasa metálica disponible en plata o negro
- Envase en cartón individual (1)
- Incluido un acoplamiento indicado para todos los Pop-Up (2) y un acoplamiento indicado para múltiples stands (3)

**Colour temperature** 3000 kelvin  
**Light brightness** 1000 lumen

**Power consumption** 150 watt  
**Length power cable** 350 cm  
**Consistent burning hours** 1000 hours

Art. nr.      Colour

WLH150B      ●  
 WLH150S      ●

All sizes in cm.

**Package** See fig. 1b on page 3

W	H	D	KG	⊗ in (Y)	⊗ in (Z)
34	55	95	25	10	30
34	55	95	25	10	30



# Lighting Options



## Luxurious Light Bag

- EN Suitable for storing 3 lights
- DE Zum aufbewahren von 3 Lampen
- NL Geschikt voor opbergen van 3 lampen
- FR Convient pour contenir 3 lampes
- ES Apropiado para guardar 3 luces



Art. nr.	Product	Suitable light types	W	H	D
L-BAG-M	Luxurious Light Bag M	BLED, BLH35, BLH50, WLED50	16	56	12
L-BAG-L	Luxurious Light Bag L	WLED116, WLH150	16	68	13,5

All sizes in cm.

## Banner Light Clip

- EN Suitable for any banner type due to universal clip
- DE Geeignet für alle Banner-Systeme mittels Universalklemme
- NL Geschikt voor iedere banner dankzij universele klem
- FR Adaptable à toutes les bannières grâce au clip universel
- ES Adecuado para todo tipo de banner con la pinza universal



Art. nr.  
BLC



## Wall Light Clamp Tube

- EN Tube clamp for  $\varnothing$  30 - 34 mm tubes
- DE Rohrklemme für  $\varnothing$  30 - 34 mm Rohre
- NL Buis klem voor buizen van  $\varnothing$  30 - 34 mm
- FR Fixation pour tubes de  $\varnothing$  30 - 34 mm
- ES Abrazadera para tubos de  $\varnothing$  30 - 34 mm

Art. nr. Colour

WLCTB	●
WLCTW	○
WLCTS	●



## Wall Light Clamp Wall

- EN Wall clamp up to max 53 mm
- DE Wandklemme bis max. 53 mm
- NL Wandklem tot maximaal 53 mm
- FR Fixation murale max. 53 mm
- ES Abrazadera de pared 53 mm máx.

Art. nr. Colour

WLCWB	●
WLCWW	○
WLCWS	●



# Counters

Promotional	106
Professional Original M	108
Professional Original L	110
Professional Square	112
Professional Round	114
Fabric	116
Flex Counter	118



# Counter Promotional

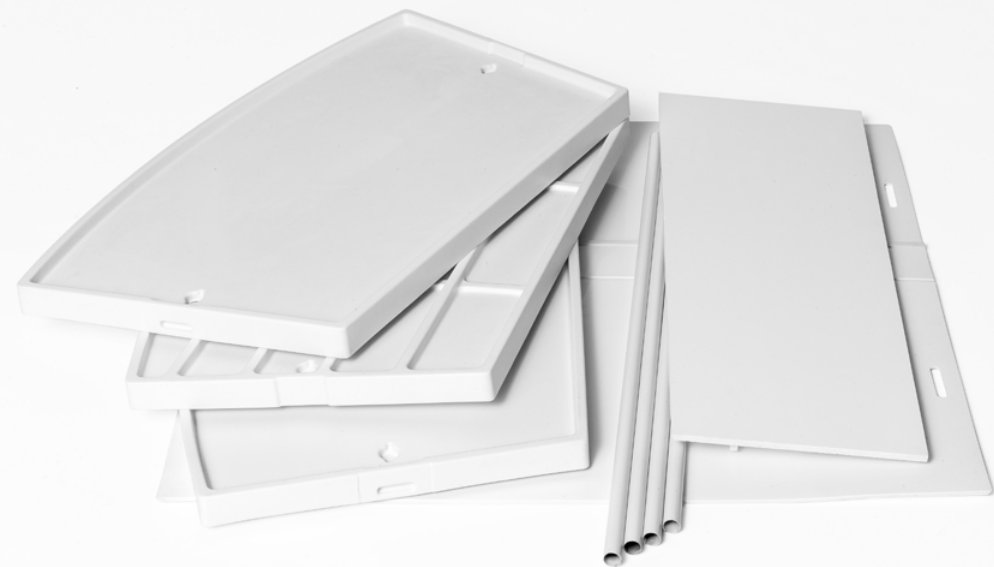

1



2

3



4



## Counter **Promotional**

### EN

- Completely (de)mountable in parts (1)
- Strong support shelf (2)
- Click and mount system (3)
- Braced transporter bag (4)

### DE

- Komplett demontierbar (1)
- Starker Einlegeboden mit Stützfunktion (2)
- Klick-Montagesystem (3)
- Verstärkte Transporttasche (4)

### NL

- Volledig demonteerbaar in losse onderdelen (1)
- Stevige legplank (2)
- Klik montagesysteem (3)
- Verstevigde transporttas (4)

### FR

- Entièrement démontable (1)
- Étagère robuste (2)
- Système 'cliper et monter' (3)
- Sac de transport renforcé (4)

### ES

- Completamente desmontable (1)
- Estante de soporte sólido (2)
- Sistema de montaje 'click and go' (3)
- Bolsa de transporte reforzada (4)

# 100

Art. nr.  
**CPRM**  
All sizes in cm.

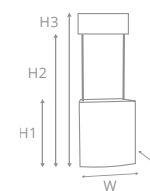

### Dimensions

W	H1	H2	H3	D
82	90	185	215	47

### Package *See fig. 1a on page 3*

W	H	D	KG
13	94	87	11

### Pallet capacity *See fig. 2a on page 3*

Euro	Industrial
12	20

*Max. pcs. on pallet*

# Counter Professional Original M

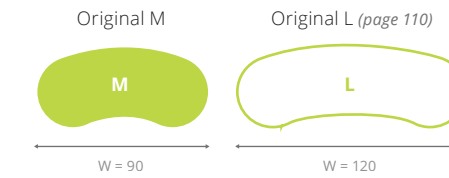
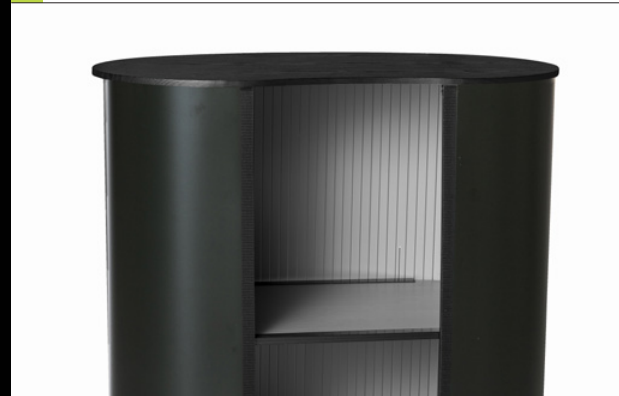
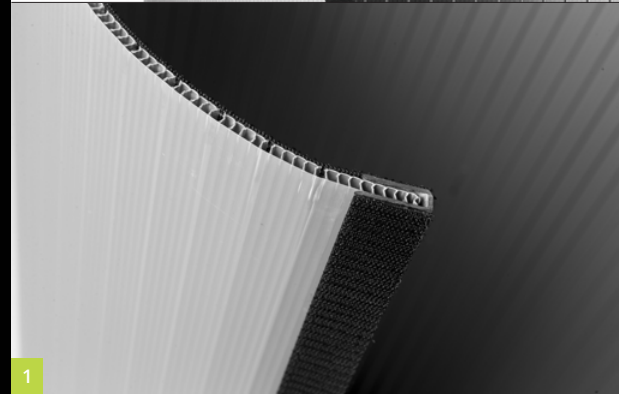

**IMPROVED**  
Improved canal structure sheet for better shaping



Art. nr. CPOMSHELF  
Product Plastic Shelf (4)

## Counter Professional Original M

- EN**
- Extremely stable because of curved shape
  - Canal structure sheet, with black hook velcro (hard) (1)
  - Table top available in: black / wood / silver / white (2)
  - Padded bag for table tops and cylindrical bag with cardboard tube for plastic roll and print (3)
  - **Optional:** Plastic shelf (4)

- DE**
- Extrem stabil mit hoher Standfestigkeit aufgrund gekrümmter Form
  - Lamellenbahn mit Hakenband (1)
  - Thekenplatte verfügbar in: schwarz / holz / silber / weiß (2)
  - Tasche mit Innenfutter für Holzplatten und Köchertasche mit Papprolle für Kunststoffrolle und Druck (3)
  - **Optionel:** Kunststoffeinlegeplatte (4)

- NL**
- Extreem stabiel door gebogen vorm
  - Lamellenrol met haak klittenband (hard) (1)
  - Balieblad beschikbaar in: zwart / hout / zilver / wit (2)
  - Tas met binnenvoering t.b.v. houten bladen en kokertas met kartonnen koker t.b.v. kunststof rol en print (3)
  - **Optioneel:** Kunststof legplank (4)

- FR**
- Extrêmement stable grâce à sa forme courbée
  - Structure alvéolaire avec velcro (côté dur) (1)
  - Tablette supérieure disponible en: noir / bois / argent / blanc (2)
  - Sac renforcé avec rangement pour tablettes ainsi qu'un sac en cylindre avec tubes en carton pour les imprimés et les rouleaux plastiques (3)
  - **Optionnel:** Étagère en plastique (4)

- ES**
- Extremadamente estable por su forma curva
  - Estructura laminar con velcro de gancho (cara dura) (1)
  - Tablero disponible en: negro / madera / gris plateado / blanco (2)
  - Bolsa acolchada para los tableros y bolsa cilíndrica con tubo de cartón para el material plástico e impresión (3)
  - **Opcional:** Estante plástico (4)

Art. nr.	Colour
CPOMTTB	●
CPOMTTW	●
CPOMTTS	●
CPOMTTWH	○

All sizes in cm.

### Dimensions

W	H	D
91	93	48
91	93	48
91	93	48
91	93	48

### Package See fig. 1a on page 3

W	H	D	KG	(X) in (Y)
50	93	40	30	2
50	93	40	30	2
50	93	40	30	2
50	93	40	30	2

### Pallet capacity See fig. 2a on page 3

Euro	Industrial
16	24
16	24
16	24
16	24

Max. pcs. on pallet



**Counter**  
**Professional**  
**Original L**

**NEW**

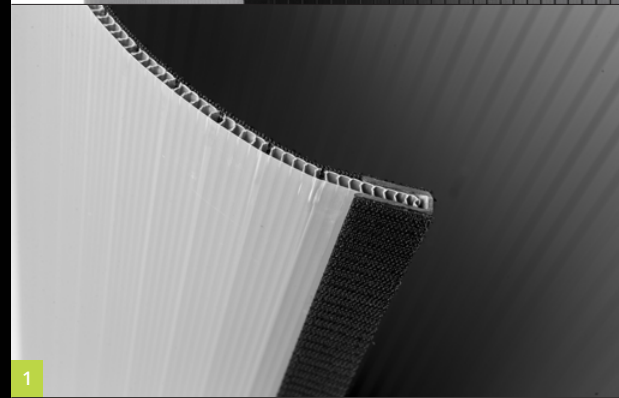

1

2

3: Optional

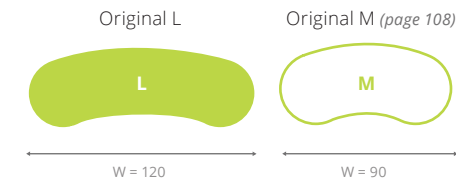

Counter **Professional Original L**

**EN**

- Extremely stable because of curved shape
- Canal structure sheet, with black hook velcro (hard) (1)
- Black table top
- Padded bag for table tops and cylindrical bag with cardboard tube for plastic roll and print (2)
- **Optional:** Wooden shelf (3)

**DE**

- Extrem stabil mit hoher Standfestigkeit aufgrund gekrümmter Form
- Lamellenbahn mit Hakenband (1)
- Schwarze Thekenplatte
- Tasche mit Innenfutter für Holzplatten und Köchertasche mit Papprolle für Kunststoffrolle und Druck (2)
- **Optional:** Einlegeplatte aus Holz (3)

**FR**

- Stabilité renforcée grâce à sa forme courbée
- Structure alvéolaire avec velcro (côté dur) (1)
- Tablette supérieure noir
- Sac renforcé avec rangement pour tablettes ainsi qu'un sac en cylindre avec tubes en carton pour les imprimés et les rouleaux plastiques (2)
- **Optionnel :** Étagère en bois (3)

**NL**

- Extreem stabiel door gebogen vorm
- Lamellenrol met haak klittenband (hard) (1)
- Zwart balieblad
- Tas met binnenvoering t.b.v. houten bladen en kokertas met kartonnen koker t.b.v. kunststof rol en print (2)
- **Optioneel:** Houten legplank (3)

**ES**

- Extremadamente estable por su forma curvada
- Estructura laminar con velcro de gancho (cara dura) (1)
- Tablero de mesa negro
- Bolsa acolchada para los tableros y bolsa cilíndrica con tubo de cartón para el material plástico e impresión (2)
- **Opcional:** Estante de madera (3)

Art. nr.  
CPOLSHLF

Product  
Wooden Shelf (3)

**Dimensions**

W	H	D
120	93	48

**Package**

See fig. 1a on page 3

	W	H	D	KG
<b>Table top:</b>	22	22	93	3
<b>Canal structure:</b>	50	9	123	12

**Pallet capacity**

See fig. 2a on page 3

Euro	Industrial
13	20

Max. pcs. on pallet

All sizes in cm.

# Counter Professional Square

NEW

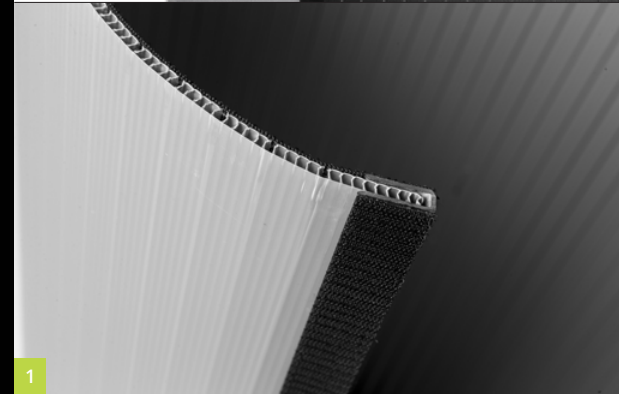

1



2



3: Optional



Art. nr.  
CPSSHELF

Product  
Plastic Shelf (3)

## Counter Professional Square

### EN

- Canal structure sheet, with black hook velcro (hard) (1)
- Black table top
- Padded bag for table top and cylindrical bag with cardboard tube for plastic roll and print (2)
- **Optional:** Plastic shelf (3)

### DE

- Lamellenbahn mit Hakenband (1)
- Schwarze Thekenplatte
- Tasche mit Innenfutter für Holzplatten und Köchertasche mit Papprolle für Kunststoffrolle und Druck (2)
- **Optional:** Kunststoffeinlegeplatte (3)

### NL

- Lamellenrol met haak klittenband (hard) (1)
- Zwart balieblad
- Tas met binnenvoering t.b.v. houten bladen en kokertas met kartonnen koker t.b.v. kunststof rol en print (2)
- **Optioneel:** Kunststof legplank (3)

### FR

- Structure alvéolaire avec velcro (côté dur) (1)
- Tablette supérieure noire
- Sac renforcé avec rangement pour tablettes ainsi qu'un sac en cylindre avec tubes en carton pour les imprimés et les rouleaux plastiques (2)
- **Optionnel :** Étagère en plastique (3)

### ES

- Estructura laminar con velcro de gancho (cara dura) (1)
- Tablero de mesa negro
- Bolsa acolchada para los tableros y bolsa cilíndrica con tubo de cartón para el material plástico e impresión (2)
- **Opcional:** Estante plástico (3)

Art. nr. Colour

CPSTTB ●

All sizes in cm.

### Dimensions

W	H	D
100	93	40

### Package See fig. 1a on page 3

W	H	D	KG	X in Y
45	45	105	31,5	2

### Pallet capacity See fig. 2a on page 3

Euro	Industrial
10	20

Max. pcs. on pallet



# Counter Professional Round

NEW

'A true all-rounder'

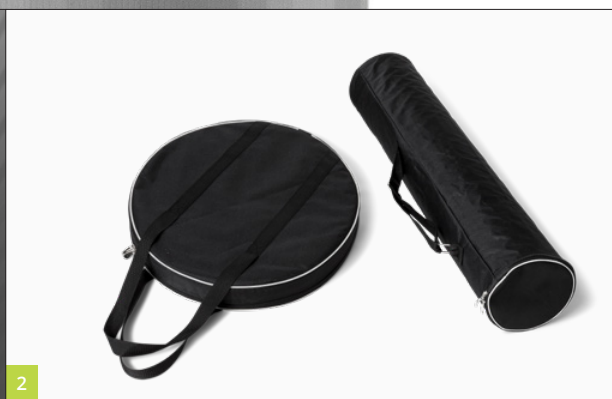
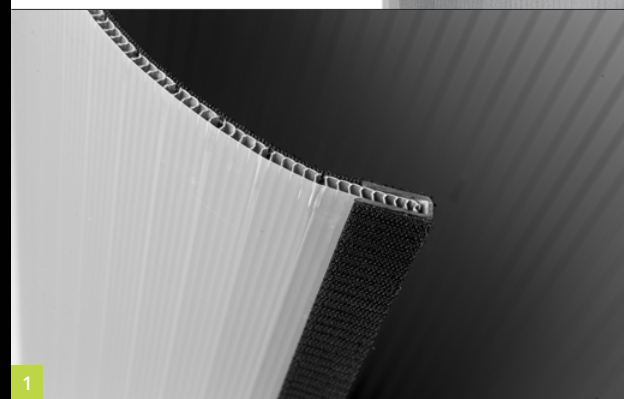

## Counter Professional Round

### EN

- Extremely stable because of round shape
- Canal structure sheet, with black hook velcro (hard) (1)
- Black table top
- Padded bag for table top and cylindrical bag with cardboard tube for plastic roll and print (2)

### DE

- Extrem stabil mit hoher Standfestigkeit aufgrund von runder Form
- Lamellenbahn mit Hakenband (1)
- Schwarze Thekenplatte
- Tasche mit Innenfutter für Holzplatten und Köchertasche mit Papprolle für Kunststoffrolle und Druck (2)

### NL

- Extreem stabiel door ronde vorm
- Lamellenrol met haak klittenband (hard) (1)
- Zwart balieblad
- Tas met binnenvoering t.b.v. houten bladen en kokertas met kartonnen koker t.b.v. kunststof rol en print (2)

### FR

- Stabilité renforcée grâce à sa forme courbée
- Structure alvéolaire avec velcro (côté dur) (1)
- Tablette supérieure noire
- Sac renforcé avec rangement pour tablettes ainsi qu'un sac en cylindre avec tubes en carton pour les imprimés et les rouleaux plastiques (2)

### ES

- Extremadamente estable por su forma curva
- Estructura laminar con velcro de gancho (cara dura) (1)
- Tablero de mesa negro
- Bolsa acolchada para los tableros y bolsa cilíndrica con tubo de cartón para el material plástico e impresión (2)

108

Art. nr. Colour

CPRTTB ●

All sizes in cm.

### Dimensions

Ø	H
45	93

### Package See fig. 1a on page 3

W	H	D	KG	⊗ in ⊙
48	30	97	16	2

### Pallet capacity See fig. 2a on page 3

Euro	Industrial
24	32

Max. pcs. on pallet

# Counter Fabric



1



2



3



4



5



6: Optional

## Optional velcro (6)

Product	Velcro Loop (soft side)
Art. nr.	VEL50L
Width	50mm
Length	25m



## Counter Fabric

### EN

- Matt black powder coated aluminium frame (1)
- Wooden shelf in the same colour as table top (2)
- Table top available in: black / wood / silver / white (3)
- Trolley with zipper over full length (4)
- Wide wheel base with ball bearing wheels (5)
- **Optional:** Loop velcro (soft side) available (6)

### DE

- Mattschwarzer pulverbeschichteter Aluminiumrahmen (1)
- Einlegeplatte aus Holz in Farbe der Thekenplatte (2)
- Thekenplatte verfügbar in: schwarz / holz / silber / weiß (3)
- Trolley mit Reißverschluss über die ganze Taschenlänge (4)
- Breiter Radstand mit kugelgelagerten Rädern (5)
- **Optional:** Flauschband erhältlich (6)

### NL

- Matzwart gepoedercoat aluminium frame (1)
- Houten legplank in dezelfde kleur als balieblad (2)
- Balieblad beschikbaar in: zwart / hout / zilver / wit (3)
- Trolley met ritssluiting over volledige lengte (4)
- Brede wielbasis met kogelgelagerde wielen (5)
- **Optioneel:** Lus klittenband (zachte kant) beschikbaar (6)

### FR

- Structure aluminium revêtement poudre noir (1)
- Étagère en bois de la même couleur que la tablette (2)
- Tablette supérieure disponible en: noir / bois / argent / blanc (3)
- Valise avec fermeture éclair sur toute la longueur (4)
- Roues situées de chaque côtés dotées de roulement à billes (5)
- **Optionnel :** Côté souple velcro (femelle) disponible (6)

### ES

- Marco de aluminio lacado, color negro mate (1)
- Estante de madera del mismo color que el tablero (2)
- Tablero disponible en: negro / madera / gris plateado / blanco (3)
- Trolley con cremallera en todo la longitud (4)
- Amplia distancia entre ruedas con rodamientos de bolas (5)
- **Opcional:** Velcro de bucle (cara suave) disponible (6)

# 110

Art. nr.	Colour
CFTTB	●
CFTTW	●
CFTTS	●
CFTTWH	○

All sizes in cm.

## Dimensions

W	H	D
106	102	40
106	102	40
106	102	40
106	102	40

## Package *See fig. 1a on page 3*

W	H	D	KG
45	115	26	18
45	115	26	18
45	115	26	18
45	115	26	18

## Pallet capacity *See fig. 2a on page 3*

Euro	Industrial
13	14
13	14
13	14
13	14

Max. pcs. on pallet



# Counter Flex

NEW



1



2



3



4



5: Optional



Optional PVC Panels for new visuals (5)

Product 8 extra PVC panels  
Art. nr. FLP-SET

## Counter Flex

### EN

- Completely foldable aluminium frame (1)
- White table top (2)
- Including 8 translucent PVC panels (3)
- Padded trolley with cover to protect panels and prints (4)
- **Optional:** 8 extra PVC panels for new visuals (5)

### DE

- Vollständig einklappbarer Aluminiumrahmen (1)
- Weiße Thekenplatte (2)
- Inklusive 8 durchsichtige PVC Paneele (3)
- Gepolsterter Trolley mit Schutz für Paneele und Drucke (4)
- **Optional:** 8 zusätzliche PVC-Paneele für neue Drucke (5)

### NL

- Volledig inklapbaar aluminium frame (1)
- Wit balieblad (2)
- Inclusief 8 transparante PVC panelen (3)
- Gevoerde trolley met hoes voor bescherming panelen en prints (4)
- **Optioneel:** 8 extra PVC panelen voor nieuwe prints (5)

### FR

- Cadre aluminium entièrement repliable (1)
- Tablette supérieure blanche (2)
- Inclus 8 panneaux transparents (3)
- Sac de transport matelassé avec protections individuelles pour les panneaux et impressions (4)
- **Optionnel :** 8 panneaux en PVC supplémentaires pour les visuels nouveaux (5)

### ES

- Estructura de aluminio completamente plegable (1)
- Tablero de mesa blanco (2)
- Incluye 8 paneles translúcidos de PVC (3)
- Trolley acolchado con cubierta para proteger los paneles e impresiones (4)
- **Opcional:** 8 paneles de PVC adicionales para nuevas impresiones (5)

112

Art. nr.

FLC

All sizes in cm.

### Dimensions

Ø	H
58	106

### Package See fig. 1a on page 3

W	H	D	KG
63	23	70	17

### Pallet capacity See fig. 2a on page 3

Euro	Industrial
15	18

Max. pcs. on pallet

# Flex Tower

Flex Tower

122

114

**5** YEAR  
WARRANTY  
★★★★★



# Flex Tower

NEW



1



2



3



4



5



## Optional PVC Panels for new visuals (5)

Product Art. nr. 8 extra PVC panels FLP-SET

## Flex Tower

### EN

- Completely foldable aluminium frame (1)
- Translucent shelves, max 5 kg
- Including 16 translucent PVC panels (2)
- Built in 15 watt LED spotlight for an eye-catching light effect (3)
- Padded trolley with cover to protect panels and prints (4)
- **Optional:** 8 extra PVC panels for new visuals (5)

### DE

- Vollständig einklappbarer Aluminiumrahmen (1)
- Durchsichtige Einlegeplatten, max. 5 kg
- Inklusive 16 durchsichtige PVC Paneele (2)
- 15 Watt LED-Einbauspot für auffällige Lichteffekte (3)
- Gepolsterter Trolley mit Schutz für Paneele und Drucke (4)
- **Optional:** 8 zusätzliche PVC-Paneele für neue Drucke (5)

### NL

- Volledig inklapbaar aluminium frame (1)
- Transparante legplaten, max 5 kg
- Inclusief 16 transparante PVC panelen (2)
- Ingebouwde 15 watt LED spot voor een opvallend lichteffect (3)
- Gevoerde trolley met hoes voor bescherming panelen en prints (4)
- **Optioneel:** 8 extra PVC panelen voor nieuwe prints (5)

### FR

- Cadre aluminium entièrement repliable (1)
- Étagères transparentes, max 5 kg
- Inclus 16 panneaux transparents (2)
- Spot 15 watts LED intégré pour éclairer les produits (3)
- Sac de transport matelassé avec protections individuelles pour les panneaux et impressions (4)
- **Optionnel :** 8 panneaux en PVC supplémentaires pour les visuels nouveaux (5)

### ES

- Estructura de aluminio completamente plegable (1)
- Estantes translúcidos, máx 5 kg
- Incluye 16 paneles translúcidos de PVC (2)
- Incluye proyector LED de 15 vatios llamativo efecto de luz (3)
- Trolley acolchado con funda para la protección de los paneles e impresiones (4)
- **Opcional:** 8 paneles de PVC adicionales para nuevas impresiones (5)

116

Art. nr.

FLTWR

All sizes in cm.

## Dimensions

Ø	H
57	206

## Package

W	H	D	KG
61	28	68	25.5

## Pallet capacity See fig. 2a on page 3

Euro	Industrial
12	15

Max. pcs. on pallet

# Brochure Holders

Magnetic	126
Budget	128
Easy	130
ZigZag	132
Deluxe	134



# Brochure Holder Magnetic



## Brochure Holder **Magnetic**

### EN

- Size: Business card (1)
- Size: DIN long (2)
- Size: A5 (3)
- Size: A4 (4)
- Attached to banner with two pairs of powerful disk magnets

### DE

- Format: Visitenkarte (1)
- Format: DIN lang (2)
- Format: A5 (3)
- Format: A4 (4)
- Mit zwei kraftvollen Scheibenmagneten am Banner befestigt

### NL

- Formaat: Visitekaartje (1)
- Formaat: DIN lang (2)
- Formaat: A5 (3)
- Formaat: A4 (4)
- Bevestigd aan de banner met twee paar krachtige schijfmagneten

### FR

- Format: Carte de visite (1)
- Format: DIN long (2)
- Format: A5 (3)
- Format: A4 (4)
- Suspendu au banner par deux paires de aimants puissants

### ES

- Tamaño: Tarjeta de visita (1)
- Tamaño: DIN largo (2)
- Tamaño: A5 (3)
- Tamaño: A4 (4)
- Unido al banner con dos pares de imanes potentes en forma de disco

# 120

Art. nr. Size

**BHMB** Business card  
**BHMDIN** Din long  
**BHMA5** A5  
**BHMA4** A4

All sizes in cm.

## Dimensions

W	H	D	Magnets
9.5	5	1.1	Ø 15x2 mm
11.5	20.5	1.1	Ø 15x2 mm
16.5	20.5	1.5	Ø 15x2 mm
23	29.5	1.8	Ø 18x3 mm

## Package *See fig. 1b on page 3*

W	H	D	KG	⊗ in ⊙	⊗ in ⊚
14	59	22	6	20	100
16	116	24	10	10	50
21	116	24	11	10	50
28	151	31	25	10	50

# Brochure Holder Budget



## Brochure Holder **Budget**

### EN

- Screwed twist-foot (1)
- Padded bag with zipper (2)

### DE

- Verschraubter Schwenkfuß (1)
- Tasche mit Innenfutter und Reißverschluss (2)

### NL

- Geschroefde draaivoet (1)
- Tas met binnenvoering en ritssluiting (2)

### FR

- Pieds à fermeture vissé (1)
- Sac renforcé avec fermeture éclair (2)

### ES

- Pie giratorio atornillado (1)
- Bolsa acolchada con cremallera (2)

Art. nr.

**BHB4**  
**BHB8**

All sizes in cm.

### Dimensions

Size	W	H	D
A4 (Single)	27	135	41
A4 (Double)	51	135	41

### Package See fig. 1a on page 3

W	H	D	KG	⊗ in ⊙
45	19	60	12	10
45	19	60	15	10

### Pallet capacity See fig. 2a on page 3

Euro	Industrial
350	400
350	400

Max. pcs. on pallet



# Brochure Holder Easy

'Make a stand'



1



2

## Brochure Holder **Easy**

### EN

- Padded bag with zipper (1)
- Single piece cardboard packaging (2)

### DE

- Tasche mit Innenfutter und Reißverschluss (1)
- In Einzelkartonagen verpackt (2)

### NL

- Tas met binnenvoering en ritsluiting (1)
- Kartonnen stuksverpakking (2)

### FR

- Sac renforcé avec fermeture éclair (1)
- Emballage en carton individuel (2)

### ES

- Bolsa acolchada con cremallera (1)
- Embalaja en cartón individual (2)



# 124

Art. nr.

BHE5

All sizes in cm.

### Dimensions

W	H	D
24	144	30

### Package *See fig. 1a on page 3*

W	H	D	KG	⊗ in ⊙
62	79	31	24	3

### Pallet capacity *See fig. 2a on page 3*

Euro	Industrial
40	60

Max. pcs. on pallet



# Brochure Holder ZigZag



1



2



3



## Brochure Holder **ZigZag**

### EN

- Easy build up
- Aluminium frame with screwed connections (1)
- Equipped with 4 rubber feet (2)
- Solid case with foam with protection inside (3)

### DE

- Einfach aufzubauen
- Aluminiumrahmen mit Schraubverbindungen (1)
- Ausgestattet mit 4 Gummifüßen (2)
- Solider Transportkoffer mit Schaumstoffpolsterung auf der Innenseite (3)

### NL

- Eenvoudige opbouw
- Aluminium frame met geschroefde verbindingen (1)
- Voorzien van 4 rubberen voetjes (2)
- Transportkoffer met schuimbescherming aan binnenkant (3)

### FR

- Montage facilité
- Cadre en aluminium équipé de joints vissés (1)
- Équipé de 4 pieds en caoutchouc (2)
- Valise de transport robuste avec intérieur en mousse (3)

### ES

- Fácil de montar
- Estructura de aluminio con conexiones roscadas (1)
- Equipado con 4 pies de goma (2)
- Maleta resistente con protección interior de gomaespuma (3)

**Format** A4  
**Tray depth** 2,5cm

126

Art. nr.	Type
BHZZW	Wood
BHZZA	Acrylic
BHZZM	Matt

All sizes in cm.

### Dimensions

W	H	D
28	143	35
28	143	35
28	143	35

### Package *See fig. 1a on page 3*

W	H	D	KG	ⓧ in Ⓨ
49	55	37	27	3
49	55	37	27	3
49	55	37	27	3

### Pallet capacity *See fig. 2a on page 3*

Euro	Industrial
48	52
48	52
48	52

Max. pcs. on pallet

# Brochure Holder Deluxe

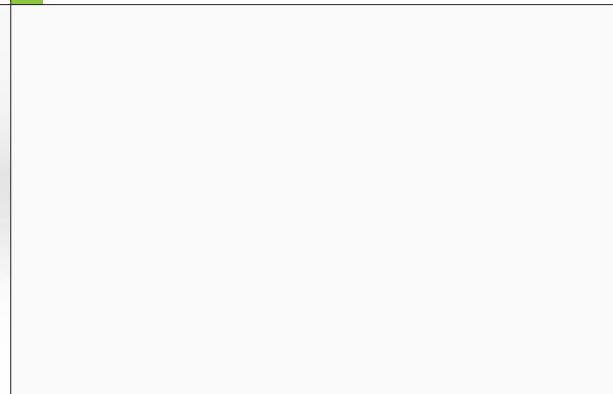
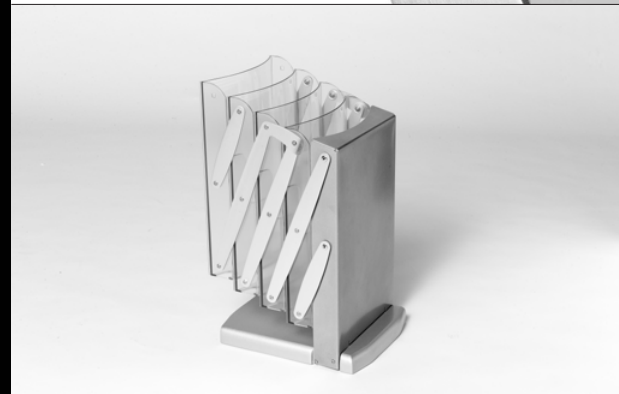

Format A4  
Tray depth 5cm



## Brochure Holder **Deluxe**

### EN

- Extremely stable brochure holder
- Easy build up
- Heavy duty base (1)
- Reinforced padded bag with zipper (2)

### DE

- Sehr stabiler Prospekthalter
- Einfach aufzubauen
- Schwerlastfuß (1)
- Verstärkte gefütterte Tasche mit Reißverschluss (2)

### NL

- Zeer stabiele brochurehouder
- Eenvoudige opbouw
- Stevige basis (1)
- Verstevigde gevoerde tas met ritssluiting (2)

### FR

- Porte brochure extrêmement stable
- Montage facilité
- Base lourde (1)
- Sac renforcé et rembourré avec fermeture éclair (2)

### ES

- Portafolletos extremadamente estable
- Fácil de montar
- Base sólida (1)
- Bolsa acolchada reforzada con cremallera (2)

Art. nr.  
BHL

### Dimensions

W	H	D
24	156	29

Package *See fig. 1a on page 3*

W	H	D	KG	⊗ in ⊙
33	54	34	8	1

Pallet capacity *See fig. 2a on page 3*

Euro	Industrial
24	36

All sizes in cm.

Max. pcs. on pallet



# Poster Holders

Poster Rail	138
Poster Frame	140
Poster Stand	142

# Poster Rail

NEW



1



## Poster Rail

### EN

- Aluminium poster rail in 7 different width sizes
- Snap-action rail on top and bottom
- Easily interchangeable prints
- Wall or ceiling mounted
- Single piece packaging
- Including 2 hooks, screws and plugs (1)

### DE

- Aluminium-Klapprahmen in 7 verschiedenen Größen
- Klemmschiene oben und unten
- Drucke einfach auswechselbar
- Befestigung an Wand oder Decke
- Einzelstück Verpackung
- Einschließlich 2 Haken, Schrauben und Dübeln (1)

### NL

- Aluminium posterrail in 7 verschillende breedte maten
- Klemprofiel boven en onder
- Makkelijk verwisselbare prints
- Bevestig aan de muur of het plafond
- Stuksverpakking
- Inclusief 2 ophangogen, schroeven en pluggen (1)

### FR

- Cadre à clipser en aluminium dans 7 largeurs différentes
- Rail à clips en haut et en bas
- Visuels facilement interchangeables
- Fixé au mur ou au plafond
- Emballage individuel
- 2 œillets de suspension, vis et chevilles inclus (1)

### ES

- Perfil de aluminio en 7 anchos diferentes
- Perfil superior e inferior abatible
- Visuales fácilmente intercambiables
- Montaje en muro o techo
- Empaquetado por unidad
- Incluye 2 ganchos, tornillos y tapones (1)

## Art. nr.

PR-A4  
PR-A3  
PR-A2  
PR-A1  
PR-A0  
PR-100  
PR-120

All sizes in cm.

## Dimensions

### W

21  
29,7  
42  
59,4  
84,1  
100  
120



# Poster Frame

NEW

'Snap to attention'



2: Landscape and portrait



3



## Poster **Frame**

### EN

- Aluminium snap frame in 4 different sizes (1)
- Width frame: 25 mm
- Adjustable to landscape & portrait (2)
- Single piece cardboard packaging
- Including screws and plugs (3)

### DE

- Aluminium-Klapprahmen in 4 verschiedenen Größen (1)
- Breite des Rahmens: 25 mm
- Montierbar in Landschaft- und Portraitformat (2)
- Einzelstück Kartonverpackung
- Einschließlich Schrauben und Dübeln (3)

### NL

- Aluminium kliklijst in 4 verschillende maten (1)
- Breedte lijst: 25 mm
- Landscape en portrait monteerbaar (2)
- Kartonnen stuksverpakking
- Inclusief schroeven en pluggen (3)

### FR

- Cadre à clipser en aluminium dans 4 tailles différentes (1)
- Largeur de cadre : 25 mm
- Ajustable en mode paysage ou portrait (2)
- Emballage par carton individuel
- Vis et chevilles incluses (3)

### ES

- Marco de aluminio en 4 tamaños distintos (1)
- Ancho del marco: 25 mm
- Ajustable en posición de paisaje o de retrato (2)
- Embalaje en cartón individual
- Incluye tornillos y tapones (3)

### Art. nr.

PF-A4  
PF-A3  
PF-A2  
PF-A1

### Dimensions

W	H
21	29,7
29,7	42
42	59,4
59,4	84,1

### Package

W	H	D	KG
26	2	34,5	0,6
34,5	2	46,5	0,7
46,5	2	64,5	1,2
64,5	2	89,5	2,1

All sizes in cm.

# Poster Stand

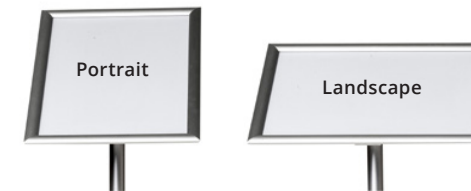

PSA4 & PSA3: Adjustable to landscape & portrait

## Poster Stand

### EN

- Aluminium snap frame A4 or A3 (1)
- Brochure holder acrylic (2)
- Adjustable to landscape & portrait (3)
- Rubber protection under base (4)
- Easily (de)mountable in parts (5)
- Padded transporter bag (6)

### DE

- Aluminium-Klapprahmen A4 oder A3 (1)
- Prospekthalter Acryl (2)
- Montierbar in Landschaft- und Portraitformat (3)
- Gummischutz am Fuß (4)
- Einfach zu demontieren (5)
- Gefütterte Transporttasche (6)

### NL

- Aluminium kliklijst A4 of A3 (1)
- Brochurehouder acryl (2)
- Landscape en portrait monteerbaar (3)
- Rubberen bescherming onder voet (4)
- Eenvoudig demonteerbaar (5)
- Gevoerde transporttas (6)

### FR

- Cadre à clipser A4 ou A3 en aluminium (1)
- Porte-brochure acrylique (2)
- Ajustable en mode paysage ou portrait (3)
- Protection en caoutchouc sous la base (4)
- Facilement démontable (5)
- Sac de transport rembourré (6)

### ES

- Marco de aluminio A4 o A3 (1)
- Portafolletos acrílico (2)
- Ajustable en posición de paisaje o de retrato (3)
- Base protegida con lámina de goma (4)
- Fácilmente desmontable (5)
- Bolsa de transporte acolchada (6)

Art. nr.

PSA4  
PSA3  
PSA4A

All sizes in cm.

### Dimensions

Base	H
Ø 33	114
Ø 33	118
Ø 33	118

### Package See fig. 1a on page 3

W	H	D	KG	(X) in (Y)
8	39	36	5	4
8	39	47	5	4
8	39	36	5	4

### Pallet capacity See fig. 2a on page 3

Euro	Industrial
120	150
96	120
120	150

Max. pcs. on pallet



# Outdoor

Streetboard	146
Outdoor Banner	148

# Outdoor Streetboard

'Outdoor exposure'



## Outdoor **Streetboard**

### EN

- Aluminium snap frame
- Plastic water tank: 32 liter water, 59 kg sand (1)
- Stable transport wheels (2)

### DE

- Aluminium-Klapprahmen
- Kunststoff-Wassertank, 32 Liter Wasser, 59 kg Sand (1)
- Stabile Transporträder (2)

### NL

- Aluminium kliklijst
- Kunststof watertank, 32 liter water, 59 kg zand (1)
- Stabiele transportwielen (2)

### FR

- Cadre à clipser en aluminium
- Réservoir à eau en plastique, 32 litres d'eau, 59 kg sable (1)
- Roulettes de transport stabilisées (2)

### ES

- Macro de aluminio tipo snap frame
- Depósito de plástico para 32 litros de agua, 59 kg de arena (1)
- Ruedas de transporte estables (2)

**Water resistant** (Splash proof)

# 140

Art. nr.

SBA1

All sizes in cm.

## Dimensions

Size	W	H	D
A1 (594 x 841 mm)	80	115	51

## Package

W	H	D	KG
67	103	22	16

## Pallet capacity

See fig. 2a on page 3

Euro	Industrial
10	12

Max. pcs. on pallet

# Outdoor Banner



1



2



3



4



## Outdoor Banner

### EN

- Water tank 18 liter (1)
- Adjustable in height with aluminium clip (2)
- Fiberglass banner holders (3)
- Delivered in 2 braced transporter bags (4)

### DE

- Wassertank 18 Liter (1)
- In Höhe verstellbar, mit Aluminium Clip (2)
- Fiberglas-Grifikhalter (3)
- Lieferung in 2 verstärkten Transporttaschen (4)

### NL

- Watertank 18 liter (1)
- In hoogte verstelbaar met aluminium clip (2)
- Fiberglas bannerhouders (3)
- Geleverd in 2 verstevigde transporttassen (4)

### FR

- Réservoir à eau de 18 litres (1)
- Hauteur ajustable avec clip en aluminium (2)
- Porte-bannière en fibre de verre (3)
- Livré dans 2 sacs de transport renforcés (4)

### ES

- Depósito para 18 litros de agua (1)
- Altura ajustable con clip de aluminio (2)
- Portabandera de fibra de vidrio (3)
- Entrega en 2 bolsas de transporte reforzadas (4)

Art. nr.

OB180

All sizes in cm.

### Dimensions

W	H
80	180

### Package *See fig. 1a on page 3*

W	H	D	KG	X in Y
40	102	23	8	2

### Pallet capacity *See fig. 2a on page 3*

Euro	Industrial
30	40

Max. pcs. on pallet





# Beach Flag Alu Wind



1



2



3



4



5: Optional



## Beach Flag **Alu Wind**

### EN

- 1-part fiberglass top (1)
- Black powder coated tubes (2)
- Tube diameter 28 mm, tube thickness 1,5 mm
- Clamp ring for attachment flag (3)
- Including beach flag bag with carrying cord (4)
- **Optional:** Luxurious padded transporter bag for multiple beach flag products (5)

### DE

- Fiberglassspitze aus einem Teil gefertigt (1)
- Schwarze pulverbeschichtete Rohre (2)
- Rohrdurchmesser 28 mm, Wandstärke 1,5 mm
- Klemmring zur Befestigung der Fahne (3)
- Inklusive Beachflagtasche mit Tragegurt (4)
- **Optional:** Verstärkte Transporttasche für mehrere Beachflagprodukte (5)

### NL

- Eendelige fiberglas bovenspriet (1)
- Zwart gepoedercoate buizen (2)
- Buisdiameter 28 mm, wanddikte 1,5 mm
- Klemring voor bevestiging vlag (3)
- Inclusief beachflagtas met draagkoord (4)
- **Optioneel:** Luxe gevoerde transporttas voor meerdere beachflag producten (5)

### FR

- Tige supérieure du mât en fibre de verre (1)
- Tubes avec revêtement peinture poudrée noire (2)
- Tube de 28 mm de diamètre, épaisseur de tube 1,5 mm
- Anneau resserable permettant l'ajustement de la tension de l'impression (3)
- Sac pour le beachflag avec lanières de transport incluses (4)
- **Optionnel :** Sac de transport design et renforcé pouvant être utilisé pour différents beachflags (5)

### ES

- Pieza final de fibra de vidrio en la parte superior del mástil (1)
- Tubos lacado en negro mate (2)
- Diámetro del tubo 28 mm, grueso del tubo 1,5 mm
- Anillo de sujeción para la fijación de la bandera (3)
- Bolsa de transporte para beachflag con asa de cordón (4)
- **Opcional:** Bolsa de transporte acolchada de lujo para múltiples productos beachflag (5)

Art. nr.

BFAW205  
BFAW255  
BFAW310  
BFAW360  
BFAW415  
BFAW465  
BFAW520

All sizes in cm.

### Flag size

W	H1
89	165
89	200
89	240
89	290
89	345
89	395
89	450

### Pole height

H2
205
255
310
360
415
465
520

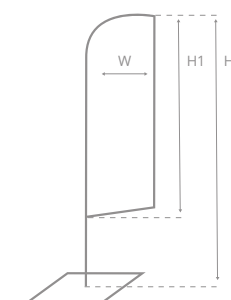

# Beach Flag Alu Drop



1



2



3



4



5: Optional



POLE HEIGHT	FLAGSIZE
235CM ←	87 X 190CM ←
290CM	87 X 245CM
345CM	87 X 290CM
400CM	107 X 335CM
520CM	127 X 435CM



Beachflag  
Alu Drop

## Beach Flag **Alu Drop**

### EN

- Two-piece fiberglass top (1)
- Black powder coated tubes (2)
- Tube diameter 28 mm, tube thickness 1,5 mm
- Clamp ring for attachment flag (3)
- Including beach flag bag with carrying cord (4)
- **Optional:** Luxurious padded transporter bag for multiple beach flag products (5)

### DE

- Zweiteilige Fiberglasspitze (1)
- Schwarze pulverbeschichtete Rohre (2)
- Rohrdurchmesser 28 mm, Wandstärke 1,5 mm
- Klemmring zur Befestigung der Fahne (3)
- Inklusive Beachflagtasche mit Tragegurt (4)
- **Optional:** Verstärkte Transporttasche für mehrere Beachflagprodukte (5)

### NL

- Tweedelige fiberglas bovenspriet (1)
- Zwart gepoedercoate buizen (2)
- Buisdiameter 28 mm, wanddikte 1,5 mm
- Klemring voor bevestiging vlag (3)
- Inclusief beachflagtas met draagkoord (4)
- **Optioneel:** Luxe gevoerde transporttas voor meerdere beachflag producten (5)

### FR

- Tige supérieure en fibre de verre formée de deux parties (1)
- Tubes avec revêtement peinture poudrée noire (2)
- Tube de 28 mm de diamètre, épaisseur de tube 1,5 mm
- Anneau resserable permettant l'ajustement de la tension de l'impression (3)
- Sac pour le beachflag avec lanières de transport incluses (4)
- **Optionnel :** Sac de transport design et renforcé pouvant être utilisé pour différents beachflags (5)

### ES

- Parte superior de fibra de vidrio en dos piezas (1)
- Rubos lacados en negro mate (2)
- Diámetro de tubo 28 mm, grosor de tubo 1,5 mm
- Anillo de sujeción para la fijación de la bandera (3)
- Bolsa de transporte para beachflag con asa de cordón (4)
- **Opcional:** Bolsa de transporte acolchada de lujo para múltiples productos beachflag (5)

Art. nr.

BFAD235  
BFAD290  
BFAD345  
BFAD400  
BFAD520

All sizes in cm.

### Flag size

W	H1
87	190
87	245
87	290
107	335
127	435

### Pole height

H2
235
290
345
400
520

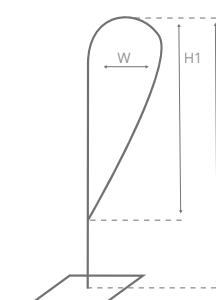



# Beach Flag Alu Square



1



2



3



4: Optional



## Beach Flag **Alu Square**

### EN

- Heavy duty angle connection (1)
- Black powder coated tubes
- Tube diameter 28 mm, tube thickness 1,5 mm
- Clamp ring for attachment flag (2)
- Including beach flag bag with carrying cord (3)
- **Optional:** Luxurious padded transporter bag for multiple beach flag products (4)

### DE

- Robuster Winkelanschluss (1)
- Schwarze pulverbeschichtete Rohre
- Rohrdurchmesser 28 mm, Wandstärke 1,5 mm
- Klemmring zur Befestigung der Fahne (2)
- Inklusive Beachflagtasche mit Tragegurt (3)
- **Optional:** Verstärkte Transporttasche für mehrere Beachflagprodukte (4)

### NL

- Stevige hoekverbinding (1)
- Zwart gepoedercoate buizen
- Buisdiameter 28 mm, wanddikte 1,5 mm
- Klemring voor bevestiging vlag (2)
- Inclusief beachflagtas met draagkoord (3)
- **Optioneel:** Luxe gevoerde transporttas voor meerdere beachflag producten (4)

### FR

- Connection angulaire renforcé (1)
- Tubes avec revêtement peinture poudrée noire (2)
- Tube de 28 mm de diamètre, épaisseur de tube 1,5 mm
- Anneau resserable permettant l'ajustement de la tension de l'impression (3)
- Sac pour le beachflag avec lanières de transport incluses (4)
- **Optionnel :** Sac de transport design et renforcé pouvant être utilisé pour différents beachflags (5)

### ES

- Unión angular sólida (1)
- Tubos lacado en negro mate
- Diámetro de tubo 28 mm, espesor de pared 1,5 mm
- Anillo de sujeción para la fijación de la bandera (3)
- Bolsa de transporte para beachflag con asa de cordón (4)
- **Opcional:** Bolsa de transporte acolchada de lujo para múltiples productos beachflag (5)

# 150

Art. nr.

BFAS240  
BFAS350  
BFAS460

All sizes in cm.

## Flag size

W	H1
60	155
85	265
85	375

## Pole height

H2
240
350
460

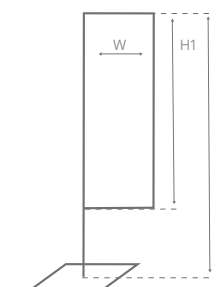

# Beach Flag Fiber Wind & Drop

'One system for  
two shapes'

152

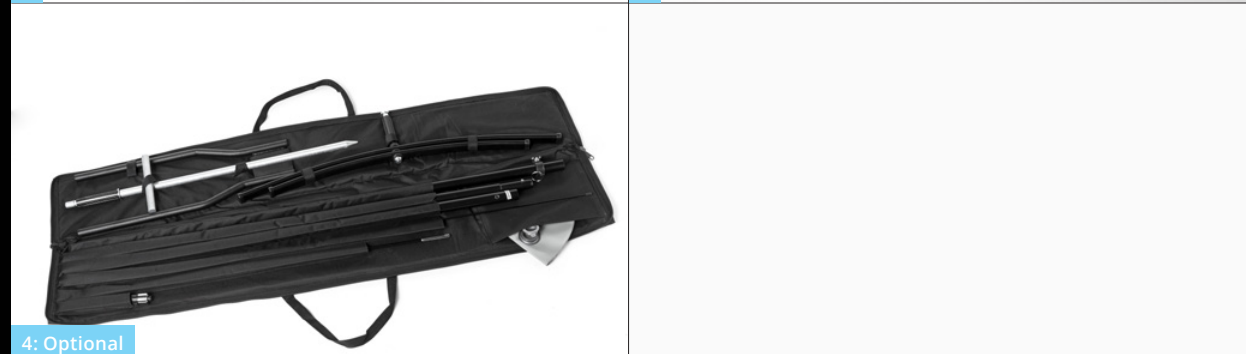
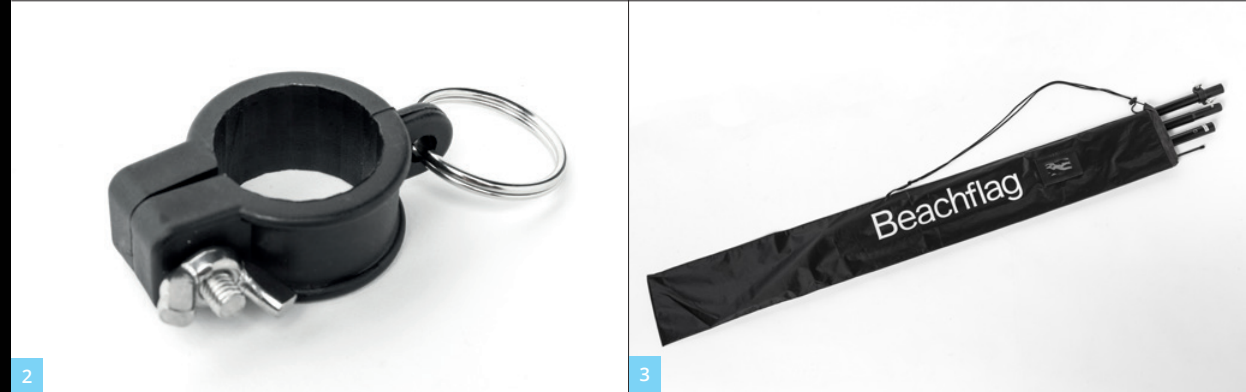

4: Optional



## Beach Flag **Fiber Wind & Drop**

### EN

- Fiberglass top (1)
- Fiberglass tubes diameter 28 mm, wall thickness 1,5 mm aluminium reinforcement diameter 31 mm
- Clamp ring for attachment flag (2)
- Including beach flag bag with carrying cord (3)
- **Optional:** Luxurious padded transporter bag for multiple beach flag products (4)

### DE

- Glasfiberspitze (1)
- Fibreglas-Rohrdurchmesser 28 mm, Wandstärke 1,5 mm, Aluminiumverstärkung Durchmesser 31 mm
- Klemmring zur Befestigung der Fahne (2)
- Inklusive Beachflagtasche mit Tragegurt (3)
- **Optional:** Verstärkte Transporttasche für mehrere Beachflagprodukte (4)

### NL

- Fibreglas bovenspriet (1)
- Fibreglas buisdiameter 28 mm, wanddikte 1,5 mm, aluminium versterking diameter 31 mm
- Klemring voor bevestiging vlag (2)
- Inclusief beachflagtas met draagkoord (3)
- **Optioneel:** Luxe gevoerde transporttas voor meerdere beachflag producten (4)

### FR

- Tige supérieure en fibre de verre (1)
- Tubes de fibre de 28 mm de diamètre, épaisseur du tube 1,5 mm, avec renforcement aluminium 31 mm de diamètre
- Anneau resserable permettant l'ajustement de la tension de l'impression (2)
- Sac pour le beachflag avec lanières de transport incluses (3)
- **Optionnel :** Sac de transport design et renforcé pouvant être utilisé pour différents beachflags (4)

### ES

- Pieza superior del mástil de fibra de vidrio (1)
- Tubos de fibra de vidrio de 28 mm de diámetro, grosor del tubo 1,5 mm, con refuerzo de aluminio 31 mm de diámetro
- Anillo de sujeción para la fijación de la bandera (2)
- bolsa de transporte para beachflag con asa de cordón (3)
- **Opcional:** Bolsa de transporte acolchada de lujo para múltiples productos beachflag (4)

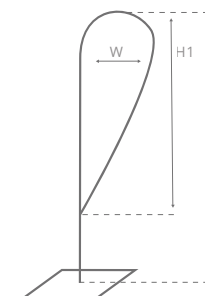

### Drop shape

Art. nr.

**BFF-S**  
**BFF-M**  
**BFF-L**  
**BFF-XL**

All sizes in cm.

### Flag size

W	H1
58	143
69	181
112	238
138	370

### Pole height

H2
185
240
310
420

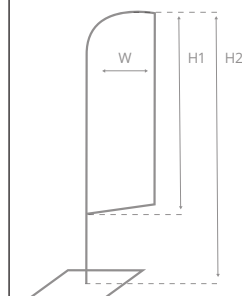

### Wind shape

Art. nr.

**BFF-S**  
**BFF-M**  
**BFF-L**  
**BFF-XL**

### Flag size

W	H1
47	156
65	194
78	285
78	403

### Pole height

H2
210
267
360
488

# Beach Flag Base

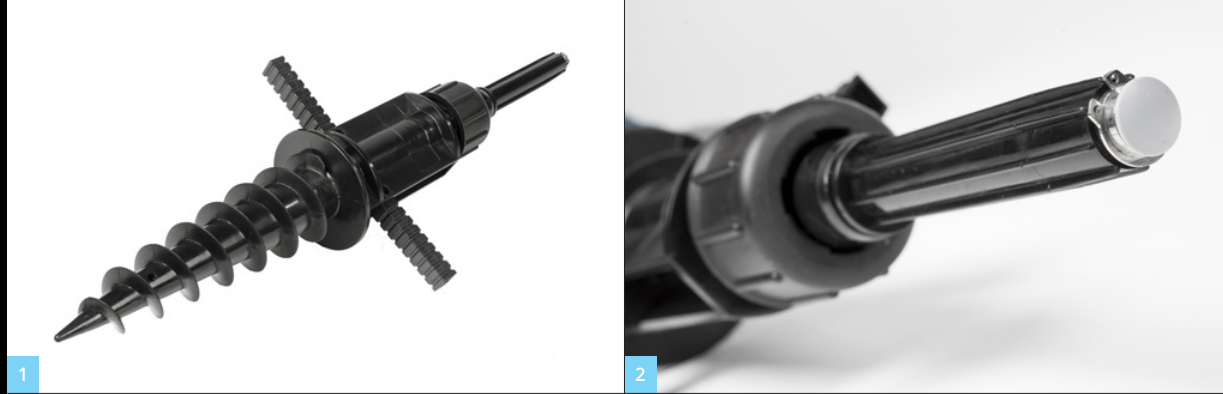

## Ground-Drill

EN

- Stainless steel, plastic (1)
- Rotator included (2)

DE

- Rostfreier Stahl, Kunststoff (1)
- Inklusive rotierendem Gelenk (2)

NL

- Roestvast staal, kunststof (1)
- Inclusief rotator (2)

FR

- Acier inoxydable, plastique (1)
- Rotateur inclus (2)

ES

- Acero inoxidable, plástico (1)
- Rotador incluido (2)

Art. nr.	Product
<b>BF-GD</b>	Ground-Drill

## Ground-Pin

EN

- Massive galvanised steel (1)
- Rotator included, perfectly suitable at very strong wind (2)

DE

- Massiver verzinkter Stahl (1)
- inklusive rotierendem Gelenk, gut geeignet bei starkem Wind (2)

NL

- Roestvat staal, kunststof (1)
- Inclusief rotator (2)

FR

- Acier inoxydable, plastique (1)
- Rotateur inclus (2)

ES

- Acero macizo galvanizado (1)
- Rotador incluido, ideal en caso de vientos fuertes (2)



Art. nr.	Product	Length	Diameter
<b>BF-GP60</b>	Ground-Pin 60	60	1,6
<b>BF-GP80</b>	Ground-Pin 80	80	2,0

*All sizes in cm.*



## Cross-Base

EN

- Black powder coated steel, rotator included
- Water bag (12 liter) (1)
- Sand bag (15 kg) (2)

DE

- Schwarzer pulverbeschichteter Stahl, inklusive rotierendem Gelenk
- Wassersack (12 Liter) (1)
- Sandsack (15 kg) (2)

NL

- Zwart gepoedercoat staal, inclusief rotator
- Waterzak (12 liter) (1)
- Zandzak (15 kg) (2)

FR

- Acier recouvert de poudre noire, rotateur inclus
- Sac à eau (12 litres) (1)
- Sac de sable (15 kg) (2)

ES

- Acero lacado en negro mate, rotador incluido
- Bolsa de agua (12 litros) (1)
- Bolsa de arena (15 kg) (2)

**NEW**

Art. nr.

**BF-CB30**  
**BF-CB50 (NEW)**

Product

Water Bag  
Sand Bag

Profile width

Cross-Base 30 30 mm  
Cross-Base 50 50 mm

## Car-Foot

EN

- Chromed rotator and hex key included (1)

DE

- Verchromtes rotierendes Gelenk und Sechskantschlüssel inklusive (1)

NL

- Inclusief verchromde rotator en inbussleutel (1)

FR

- Rotateur chromé et clé Allen inclus (1)

ES

- Rotador y llave hexagonal incluidos (1)

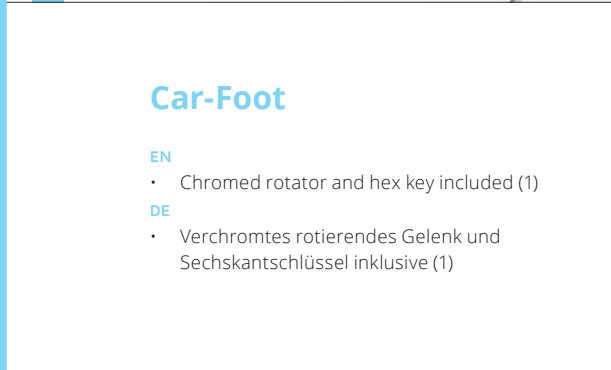

Art. nr.	Product
<b>BF-CF</b>	Car-Foot



# Beach Flag Base

## Luxurious Steel Plate

6 / 12 / 20 KG

 400 x 400 x 5 mm

 550 x 550 x 5 mm

 550 x 550 x 8 mm



- EN**
- Black powder coated steel
  - Equipped with 4 rubber feet (1)
  - Chromed rotator and hex key included (2)
  - **Optional:** Bag for steel plate (3)

- DE**
- Schwarzer pulverbeschichteter Stahl
  - Ausgestattet mit 4 Gummifüßen (1)
  - Verchromtes rotierendes Gelenk und Sechskantschlüssel inklusive (2)
  - **Optional:** Tasche für Stahlplatte (3)

- NL**
- Zwart gepoedercoat staal
  - Voorzien van 4 rubberen voetjes (1)
  - Inclusief verchromde rotator en inbusleutel (2)
  - **Optioneel:** Tas voor staalplaat (3)

- FR**
- Acier recouvert de poudre noire
  - Equipé de 4 pieds en caoutchouc (1)
  - Rotateur chromé, clé Allen inclus (2)
  - **Optionnel :** Sac pour plaque en acier (3)

- ES**
- Acero lacado en negro mate
  - Equipado de 4 patas de goma (1)
  - Dispositivo de rotación y llave hexagonal incluidos (2)
  - **Opcional:** Bolsa para base de acero (3)

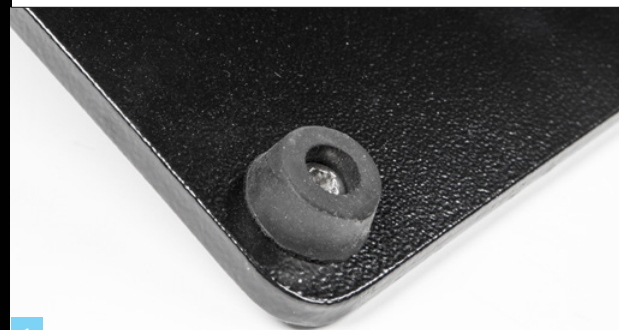

1



3: Optional



2

Art. nr.	Product
BF-ST6	Steel Plate 6 kg
BF-ST12	Steel Plate 12 kg
BF-ST20	Steel Plate 20 kg
BF-ST6BAG	Steel Plate 6 kg bag
BF-ST12.20BAG	Steel Plate 12 / 20 kg bag

## Water Tank

- EN**
- Chromed rotator included (1)
  - Carrying grip (2)
  - Transportation wheels (3)

- DE**
- Verchromtes rotierendes Gelenk inklusive (1)
  - Tragegriff (2)
  - Transporträder (3)

- NL**
- Inclusief verchromde rotator (1)
  - Handvat (2)
  - Transportwielen (3)

- FR**
- Rotateur chromé inclus (1)
  - Poignée de transport (2)
  - Roues de transport (3)

- ES**
- Rotador cromado incluido (1)
  - Asa de transporte (2)
  - Ruedas de transporte (3)



34 liter

**NEW**



24 liter



1



2



3

Art. nr.	Product
BF-WT24 (RENEWED)	Water Tank 24 liter
BF-WT34 (NEW)	Water Tank 34 liter

# Promo Flag Wind & Drop

'The pro in promotion'

158

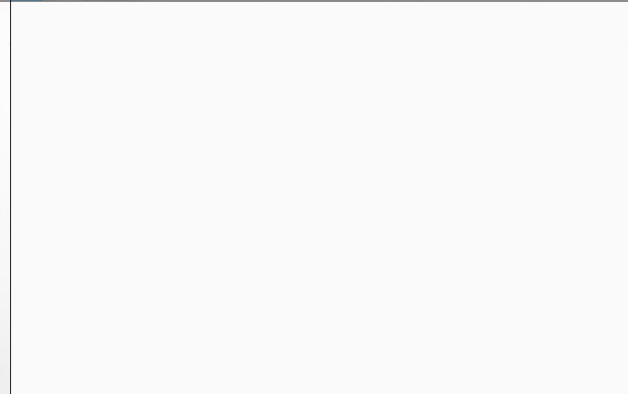
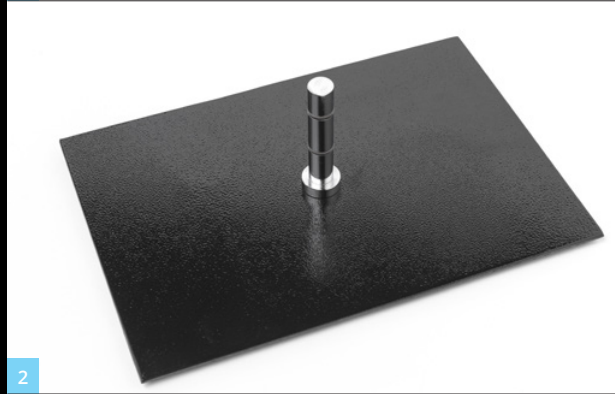

## Promo Flag Wind & Drop

EN

- Fiberglass top (1)
- Fiberglass tubes diameter 20 mm, wall thickness 1,7 mm, aluminium reinforcement diameter 22,6 mm
- Base plate rotator included (2)
- Hook for attachment of flag (3)
- Bag with separated compartment for base plate and flag (4)

DE

- Glasfiberspitze (1)
- Fiberglas-Rohrdurchmesser 20 mm, Wandstärke 1,7 mm, Aluminiumverstärkung Durchmesser 22,6 mm
- Stahlplatte und Rotator inklusive (2)
- Haken zum Befestigen der Fahne (3)
- Tasche mit separaten Fächern für die Stahlplatte und Fahne (4)

NL

- Fiberglas bovenspriet (1)
- Fiberglas buisdiameter 20 mm, wanddikte 1,7 mm, aluminium versterking diameter 22,6 mm
- Inclusief voetplaat met rotator (2)
- Haak voor bevestiging vlag (3)
- Inclusief compacte tas met apart vak voor voet en print (4)

FR

- Tige supérieur en fibre de verre (1)
- Tubes de fibre de 20 mm de diamètre, épaisseur du tube 1,7 mm, avec renforcement aluminium 22,6 mm de diamètre
- Platine et rotateur inclus (2)
- Crochet pour l'attachement de la voile (3)
- Sac avec compartiment séparés pour la platine et la voile (4)

ES

- Pieza superior del mástil de fibra de vidrio (1)
- Tubos de fibra de vidrio de 20 mm, Grueso del tubo 1,7 mm, con refuerzo de aluminio 22,6 mm de diámetro
- Platina y rotador incluido (2)
- Gancho para fijar la bandera (3)
- Bolsa de transporte con compartimento separado para la platina y la bandera (4)

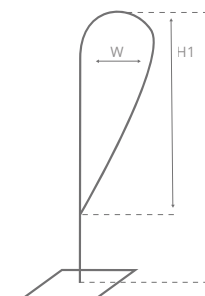

Drop shape

Art. nr.

PROFLAG

All sizes in cm.

Flag size

W	H1
45	150

Pole height

H2
196

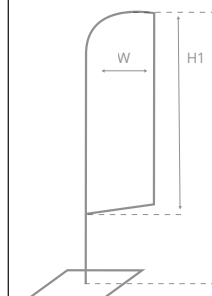

Wind shape

Art. nr.

PROFLAG

All sizes in cm.

Flag size

W	H1
40	162

Pole height

H2
205



# Flag Pole 415



1



2



3



4



5



## Flag Pole 415

### EN

- 50 liter water tank
- Aluminium tripod base (1)
- Completely screwed connections
- Clamp ring for extra fixation (2)
- Reinforced flag holder (3)
- 2 padded bags with zipper (4)
- Extra weight for down force flag (5)

### DE

- 50 Liter Wassertank
- 3 Aluminiumstützmaste (1)
- Komplett verschraubte Verbindungen
- Klemmring zur Extrasicherung (2)
- Verstärkte Fahnenmaste (3)
- 2 Taschen mit Innenfutter und Reißverschluss (4)
- Zusatzgewicht zum Straffhalten der Fahne (5)

### NL

- 50 liter watertank
- 3 aluminium mastschoren (1)
- Compleet geschroefde verbindingen
- Klemring voor extra fixatie (2)
- Verstevigde banieruithouder (3)
- 2 tassen met binnenvoering en ritssluiting (4)
- Extra gewicht om vlag strak te houden (5)

### FR

- Réservoir à eau de 50 litres
- Base tripode en aluminium (1)
- Charnières complètement vissées
- Anneau resserable pour assurer une fixation résistante (2)
- Porte drapeau renforcé (3)
- 2 sacs renforcés avec fermeture éclair (4)
- Poids supplémentaire afin de renforcer la force d'appui du drapeau (5)

### ES

- Tanque de agua de 50 litros
- Base de trípode de aluminio (1)
- Uniones completamente roscadas
- Anillo de sujeción para fijación extra (2)
- Soporte de bandera reforzado (3)
- 2 bolsas acolchadas con cremallera (4)
- Contrapeso inferior para tensar la bandera (5)

# 160

Art. nr.	Base
FP415	Ø 62

All sizes in cm.

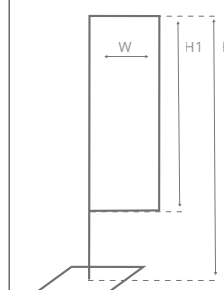

Flag size	
W	H1
80	300

Pole height
H2
415

Package	Tank				Pallet capacity	
	W	H	D	KG	Euro	Industrial
Tank	70	30	64	7	9	12
Pole	13	156	13	5,5		

Pallet capacity  
See fig. 2a on page 3



# Flag Pole 540



## Flag Pole 540

### EN

- Aluminium 4 legged base (1)
- 2 x 40 liter water tank (2)
- Screwed connections
- Clamp ring for extra fixation (3)
- Reinforced flag holder (4)
- 2 padded bags with zipper (5)
- Extra weight for down force flag (6)

### DE

- 4 Aluminiumstützmaste (1)
- 2 x 40 Liter-Wassertank (2)
- Verschraubte Verbindungen
- Klemmring zur Extrasicherung (3)
- Verstärkte Fahnenmaste (4)
- 2 Taschen mit Innenfutter und Reißverschluss (5)
- Zusatzgewicht zum straffhalten der Fahne (6)

### NL

- 4 aluminium mastschoren (1)
- 2 x 40 liter watertank (2)
- Geschroefde verbindingen
- Klemring voor extra fixatie (3)
- Verstevigde banieruithouder (4)
- 2 tassen met binnenvoering en ritssluiting (5)
- Extra gewicht om vlag strak te houden (6)

### FR

- Base 4 points en aluminium (1)
- 2 x réservoirs à eau de 40 litres (2)
- Charnières vissées
- Anneau resserable pour assurer une fixation résistante (2)
- Porte drapeau renforcé (4)
- 2 sacs renforcés avec fermeture éclair (5)
- Poids supplémentaire afin de renforcer la force d'appui du drapeau (6)

### ES

- Base de aluminio con 4 patas de aluminio (1)
- 2 x tanque de agua de 40 litros (2)
- Terminales de rosca
- Anillo de sujeción para fijación extra (3)
- Soporte de bandera reforzado (4)
- 2 bolsas acolchadas con cremallera (5)
- Contrapeso inferior para tensar la bandera (6)

Art. nr.	Base
FP540	80 x 80

All sizes in cm.

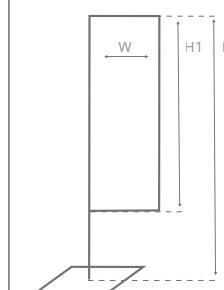

### Flag size

W	H1
110	330

### Pole height

H2
540

### Package

	W	H	D	KG
<b>Tank</b>	80	38	43	10
<b>Pole</b>	15	160	13	6,5

### Pallet capacity

See fig. 2a on page 3

Euro	Industrial
10	10

# Cases

Hard Case	172
Trolley Case	173
Transport Trolley	174
Soft Trolley	175

## Case

# Hard Case

Used for our Pop-Up Magnetic



Front side

Back side

Inner size  
65 x 80 cm (W x H)  
14 kg



1



2

### EN

- Solid twist hinges (1)
- Carrying grip on side
- Padded bag and firm divider to protect the print (2)
- Heavy duty wheels (3)

### DE

- Starke Drehscharniere (1)
- Tragegriff an der Seite
- Tasche mit Innenfutter und Mittelabtrennung zum Schutz der Drucke (2)
- Massive starke Transporträder (3)

### NL

- Sterke draaischarnieren (1)
- Draaghandvat aan zijkant
- Gevoerde zak en stevig scheidingspaneel voor bescherming print (2)
- Massieve sterke wielen (3)

### FR

- Charnières tournantes solides (1)
- Poignée sur les deux côtés
- Sac rembourré et séparateur fixe permettant de protéger les visuels imprimés (2)
- Roues hautement résistantes (3)

### ES

- Bisagras sólidas (1)
- Asa de transporte lateral
- Bolsa acolchada con separador sólido para proteger la impresión (2)
- Ruedas altamente resistentes (3)



3

### Hard Case

Art. nr.

PUHCL

### Package

W	H	D
71	100	41

All sizes in cm.

## Case

# Trolley Case

Used for our Pop-Up Fabric



Inner size medium (M)  
33 x 85 x 30 cm (W x H x D)  
5 kg

Inner size large (L)  
43 x 85 x 30 cm (W x H x D)  
5,5 kg

Inner size extra large (XL)  
53 x 85 x 30 cm (W x H x D)  
6 kg



1

### Case Trolley Case

### EN

- Extendible trolley handle (1)
- Wide wheel base with ball bearing wheels (2)

### DE

- Trolley mit ausziehbarem Griff (1)
- Breiter Radstand mit kugelgelagerten Rädern (2)

### NL

- Uitschuifbare trolley handgreep (1)
- Brede wielbasis met kogelgelagerde wielen (2)

### FR

- Poignée de valise télescopique (1)
- Position large dos roues avec roulement à billes (2)

### ES

- Asa de trolley extensible (1)
- Ancho de rueda con rodamientos de bolas (2)

### Trolley Case

Art. nr.

PUTCM  
PUTCL  
PUTCXL

Size

M  
L  
XL

### Package

W	H	D
39	98	39
48	98	39
56	98	39

All sizes in cm.



2



# Case Transport Trolley

Used for our Zipper-Walls



**Inner size medium (M)**  
25 x 119 x 12 cm (W x H x D)  
5 kg

**Inner size large (L)**  
25 x 119 x 17 cm (W x H x D)  
5,7 kg

**Inner size extra large (XL)**  
25 x 119 x 22 cm (W x H x D)  
6,4 kg



1



2

## Case **Transport Trolley**

### EN

- Reinforced transport trolley for durable professional use (1)
- Solid wheel base with ball bearing wheels (2)

### DE

- Verstärkter Transporttrolley für Langzeitgebrauch (1)
- Solide Radbasis mit kugelgelagerten Rädern (2)

### NL

- Verstevigde transporttrolley voor langdurig professioneel gebruik (1)
- Solide wielbasis met kogelgelagerde wielen (2)

### FR

- Valise de transport robuste pour une utilisation professionnelle durable (1)
- Roues solides avec roulement à billes (2)

### ES

- Trolley profesional reforzado para transporte y uso duradero (1)
- Ase sólida con ruedas con rodamientos de bolas (2)

## Transport Trolley

Art. nr.	Size	Inner height
TT120M	M	12
TT120L	L	17
TT120XL	XL	22

All sizes in cm.

## Package

W	H	D
33	132	19
33	132	23
33	132	28

# Case Soft Trolley

Used for our Counter Fabric



**Inner size**  
40 x 108 x 23 cm (W x H x D)



1

## Case **Soft Trolley**

### EN

- Extendible trolley handle
- Wide wheel base with ball bearing wheels (1)

### DE

- Trolley mit ausziehbarem Griff
- Breiter Radstand mit kugelgelagerten Rädern (1)

### NL

- Uitschuifbare trolley handgreep
- Brede wielbasis met kogelgelagerde wielen (1)

### FR

- Poignée de valise télescopique
- Roues situées de chaque côtés dotées de roulement à billes (1)

### ES

- Asa de trolley extensible
- Ancho de rueda con rodamientos de bolas (1)

## Soft Trolley

### Art. nr.

ST

All sizes in cm.

## Package

W	H	D
46	117	27